



ALLIANCE
TRUCK PARTS

WINDSHIELD WIPERS



2016 PARTS GUIDE | alliancetruckparts.com

ALL-MAKES HEAVY-DUTY WINDSHIELD WIPERS

Alliance Truck Parts has over 30 product lines that serve the commercial transportation industry with reliable new and remanufactured parts and accessories for all makes and all models¹ to keep trucks and buses on the road. All Alliance Truck Parts meet or exceed OES specifications for quality, fit and finish and are backed by a nationwide warranty², which means you don't have to trade quality for price.

ALL-MAKES HEAVY-DUTY
WINDSHIELD
WIPERS



Illustrations and photographs used in this catalog may vary slightly from the actual product. Prototype samples are sometimes used for photography. The production parts may vary slightly.

Availability of products shown in this catalog is subject to change without notice.

PARTS NUMBERING SYSTEM

PARTS NUMBERING SYSTEM

The Alliance Truck Parts numbering system is set up systematically:

Example - ABP N83 318159.

All parts numbers in this program contain the prefix ABP and N83 (the company assigned code for this program) The number following the N refers to the part segment and is different for each. The last six digits are assigned based on part and design.

All parts in the catalog are set up with an Alliance Truck Parts number. In the back of this catalog you will find an extensive cross reference list. This will help link another manufacturer's part to an Alliance ABP number.

WARRANTY

WARRANTY

Alliance truck parts are backed by a 1-year/unlimited-mile standard warranty.

NOTES

Lined writing area consisting of multiple horizontal lines for text entry.

TABLE OF CONTENTS

1	UNIVERSAL WINDSHIELD WIPERS	PAGE 2
	OEM METAL WIPER BLADES	3
	PREMIUM METAL WIPER BLADES	4
	TRADITIONAL METAL WIPER BLADES.....	5
2	NARROW SADDLE WINDSHIELD WIPERS	PAGE 6
	STAINLESS STEEL FLAT WIPER BLADES	7
	HEAVY-DUTY FLEX WIPER BLADES	8
3	SADDLE WINDSHIELD WIPERS	PAGE 10
	OEM 13.6 MM SADDLE WIPER BLADES	11
	13.6 & 17 MM SADDLE WIPER BLADES.....	12
	TRANSIT BUS WIPER BLADES	13
4	WINTER WINDSHIELD WIPERS	PAGE 14
	HOOK & PIN WINTER WIPER BLADES.....	15
	NARROW SADDLE WINTER WIPER BLADES	16
5	WINDSHIELD WIPER MOTORS	PAGE 18
	ALL-MAKES WIPER MOTORS.....	19
	WWF WIPER MOTORS.....	20
6	INSTALLATION & MAINTENANCE	PAGE 22
	WIPER PROBLEMS & CAUSES	23
	UNIVERSAL WIPER INSTALLATION INSTRUCTIONS	24
	SADDLE WIPER INSTALLATION INSTRUCTIONS.....	25
7	CROSS-REFERENCE	PAGE 26
	CROSS-REFERENCE.....	27-28
8	AUTOMOTIVE APPLICATION GUIDE	PAGE 30
	AUTOMOTIVE APPLICATIONS	31-61
9	HEAVY-DUTY APPLICATION GUIDE	PAGE 62
	TRUCK.....	63-82
	BUS.....	83-88
	RV.....	89-118

UNIVERSAL WINDSHIELD WIPERS

1



UNIVERSAL WINDSHIELD WIPERS

FEATURES & BENEFITS

- All-metal, triple-coated, anti-corrosion steel frame
- Tested for over 1 million cycles
- Exclusive aerodynamic frame to prevent windlift
- Dual stainless steel spline to assure constant pressure

SPECIFICATIONS

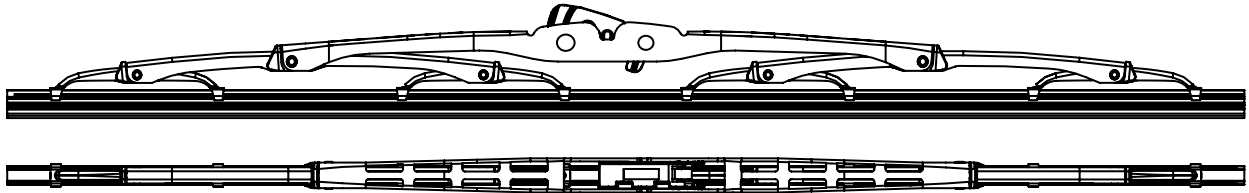

ALLIANCE P/N	ANCO	ANCO PREMIUM	TRICO EXACT-FIT
ABP N82 7311	-	-	-
ABP N82 7312	-	91-12	12-2
ABP N82 7313	-	91-13	13-1
ABP N82 7314	-	91-14	14-1, 14-2
ABP N82 7315	31-15	91-15	15-1
ABP N82 7316	31-16	91-16	16-1, 16-2
ABP N82 7317	31-17	91-17	17-1, 17-2
ABP N82 7318	31-18	91-18	18-1, 18-2
ABP N82 7319	31-19	91-19	19-1, 2, 3, 7, 9
ABP N82 7320	31-20	91-20	20-1, 2, 4, 9
ABP N82 7321	31-21	91-21	21-1, 21-9
ABP N82 7322	31-22	91-22	22-1, 4, 9
ABP N82 7324	31-24	91-24	24-1, 4, 9
ABP N82 7326	-	91-26	26-1
ABP N82 7328	-	91-28	28-9

COMMON APPLICATIONS

- Passenger cars and trucks
- Class 6, 7 and 8 trucks
- School buses
- Class C RVs
- Specialty vehicles

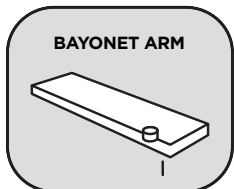
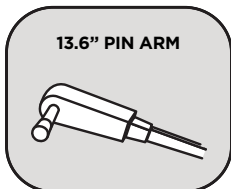
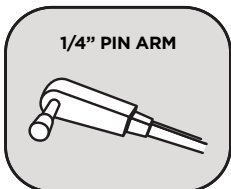

UNIVERSAL WINDSHIELD WIPERS

FEATURES & BENEFITS

- Premium all-metal, heavy-gauged, riveted steel frame
- High-density, 100% natural, molded rubber
- Universal connector

SPECIFICATIONS

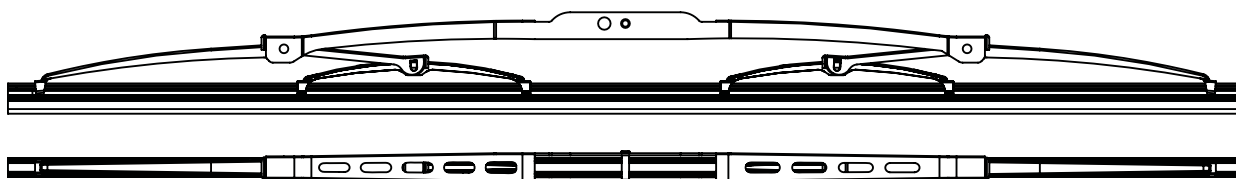

ALLIANCE P/N	ANCO	ANCO PREMIUM	TRICO EXACT-FIT
ABP N82 7612	-	91-12	12-2
ABP N82 7613	-	91-13	13-1
ABP N82 7614	-	91-14	14-1, 14-2
ABP N82 7615	31-15	91-15	15-1
ABP N82 7616	31-16	91-16	16-1, 16-2
ABP N82 7617	31-17	91-17	17-1, 17-2
ABP N82 7618	31-18	91-18	18-1, 18-2
ABP N82 7618B	31-18	91-18	18-1, 18-2
ABP N82 7619	31-19	91-19	19-1, 2, 3, 7, 9
ABP N82 7620	31-20	91-20	20-1, 2, 4, 9
ABP N82 7620B	31-20	91-20	20-1, 2, 4, 9
ABP N82 7621	31-21	91-21	21-1, 21-9
ABP N82 7622	31-22	91-22	22-1, 4, 9
ABP N82 7622B	31-22	91-22	22-1, 4, 9
ABP N82 7624	31-24	91-24	24-1, 4, 9
ABP N82 7624B	31-24	91-24	24-1, 4, 9
ABP N82 7626	-	91-26	26-1
ABP N82 7626B	-	91-26	26-1
ABP N82 7628	-	91-28	28-9
ABP N82 7628B	-	91-28	28-9

COMMON APPLICATIONS

- Passenger cars and trucks
- Class 6, 7 and 8 trucks
- School buses
- Class C RVs
- Specialty vehicles

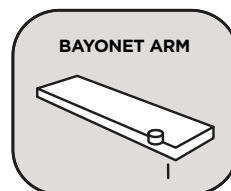
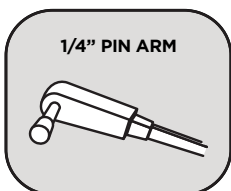

UNIVERSAL WINDSHIELD WIPERS

FEATURES & BENEFITS

- All-metal steel frame
- Long-lasting, natural, molded rubber
- Universal connector

SPECIFICATIONS

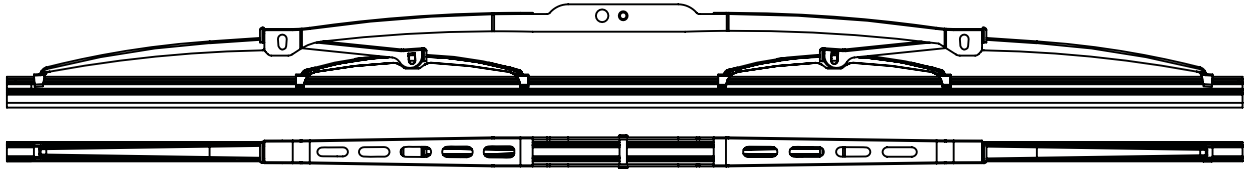

ALLIANCE P/N	ANCO	ANCO PREMIUM	TRICO EXACT-FIT
ABP N82 7512	-	91-12	12-2
ABP N82 7513	-	91-13	13-1
ABP N82 7514	-	91-14	14-1, 14-2
ABP N82 7515	31-15	91-15	15-1
ABP N82 7516	31-16	91-16	16-1, 16-2
ABP N82 7517	31-17	91-17	17-1, 17-2
ABP N82 7518	31-18	91-18	18-1, 18-2
ABP N82 7518B	31-18	91-18	18-1, 18-2
ABP N82 7519	31-19	91-19	19-1, 2, 3, 7, 9
ABP N82 7520	31-20	91-20	20-1, 2, 4, 9
ABP N82 7520B	31-20	91-20	20-1, 2, 4, 9
ABP N82 7521	31-21	91-21	21-1, 21-9
ABP N82 7522	31-22	91-22	22-1, 4, 9
ABP N82 7522B	31-22	91-22	22-1, 4, 9
ABP N82 7524	31-24	91-24	24-1, 4, 9
ABP N82 7524B	31-24	91-24	24-1, 4, 9
ABP N82 7526	-	91-26	26-1
ABP N82 7528	-	91-28	28-9

COMMON APPLICATIONS

- Passenger cars and trucks
- Class 6, 7 and 8 trucks
- School buses
- Class C RVs
- Specialty vehicles

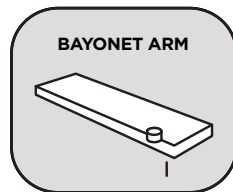
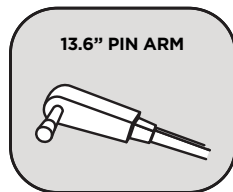
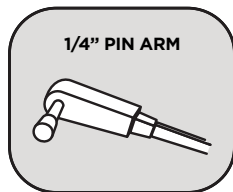

NARROW SADDLE WINDSHIELD WIPERS

2



NARROW SADDLE WINDSHIELD WIPERS

2

STAINLESS STEEL FLAT WIPER BLADES

FEATURES & BENEFITS

- Stainless steel frame
- Designed specifically for flat windshields
- All-natural, molded rubber
- In the market for over 40 years

SPECIFICATIONS

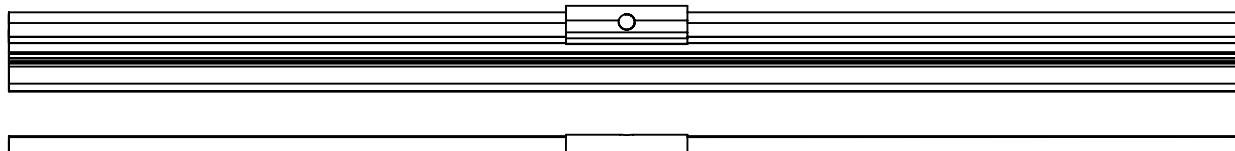

ALLIANCE P/N	ANCO	TRICO	SPRAGUE
ABP N82 7111	51-11	61-110	C-1100-11
ABP N82 7112	51-12	61-120	C-1100-12
ABP N82 7113	51-13	61-130	C-1100-13
ABP N82 7114	51-14	61-140	C-1100-14
ABP N82 7115	51-15	61-150	C-1100-15
ABP N82 7116	51-16	61-160	C-1100-16
ABP N82 7117	51-17	61-170	C-1100-17
ABP N82 7118	51-18	61-180	C-1100-18
ABP N82 7119	51-19	61-190	C-1100-19
ABP N82 7120	51-20	61-200	C-1100-20
ABP N82 7121	51-21	61-210	C-1100-21
ABP N82 7122	51-22	61-220	C-1100-22

COMMON APPLICATIONS

- Heavy-duty trucks
- Old-model school buses
- Airport ground equipment
- Postal vehicles
- Old-model refuse trucks
- Specialty vehicles

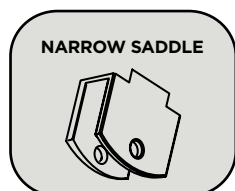

NARROW SADDLE WINDSHIELD WIPERS

FEATURES & BENEFITS

- Heavy-duty riveted frame
- Extra-heavy, all-natural rubber element
- Designed specifically for curved windshields

SPECIFICATIONS

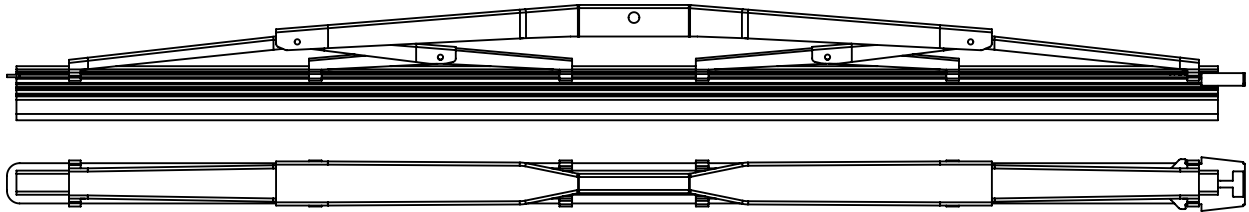

ALLIANCE P/N	ANCO		TRICO	
	BLACK	SILVER	BLACK	SILVER
ABP N82 7115	-	52-15	63-151	64-150
ABP N82 7116	57-08	52-16	63-161	64-160
ABP N82 7118	57-09	52-18	63-181	64-180
ABP N82 7120	657-10	52-20	63-201	64-200
ABP N82 7122	-	52-22	63-221	64-220

COMMON APPLICATIONS

- Heavy-duty trucks
- Old-model school buses
- Airport ground equipment
- Postal vehicles
- Old-model refuse trucks
- Specialty vehicles



WINDSHIELD WIPERS

SADDLE

3



SADDLE WINDSHIELD WIPERS



OEM 13.6 MM SADDLE WIPER BLADES

FEATURES & BENEFITS

- Designed and tested to OEM standards
- Stainless steel spline
- Zinc-coated frame to prevent rust
- Molded, chlorinated rubber for increased performance

SPECIFICATIONS

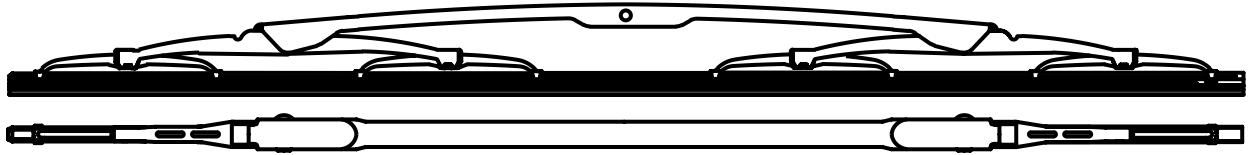

ALLIANCE P/N	ANCO	TRICO	UNITED TECHNOLOGIES
ABP N82 7724	50-24	68-241	52147
ABP N82 7726	50-24	68-261	52148
ABP N82 7728	50-24	68-281	52149
ABP N82 7730	-	-	-
ABP N82 7732	-	-	-

COMMON APPLICATIONS

- School buses
- Step vans/box trucks
- Class A RVs
- Refuse trucks
- Construction/agricultural vehicles
- Specialty vehicles

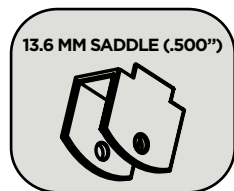

SADDLE WINDSHIELD WIPERS

FEATURES & BENEFITS

- Aerodynamic, all-metal, heavy-gauged frame
- Dual stainless steel spline
- Zinc-coated frame to prevent rust
- All necessary hardware included with each package

SPECIFICATIONS

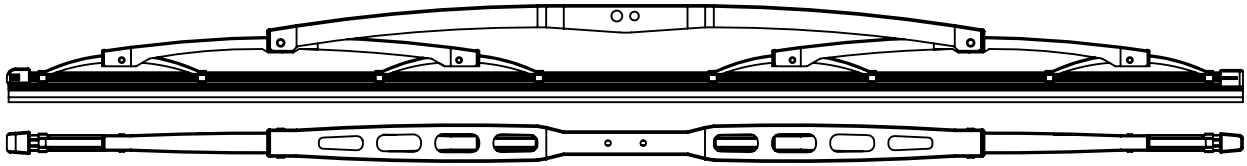

ALLIANCE P/N	BOSCH	TRICO
ABP N82 7824	3 398 110 916	67-241
ABP N82 7826	3 398 110 917	67-261
ABP N82 7828	3 398 110 918	67-281

COMMON APPLICATIONS

- School buses
- Step vans/box trucks
- Class A RVs
- Refuse trucks
- Construction/agricultural vehicles
- Specialty vehicles

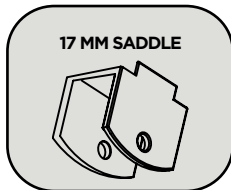
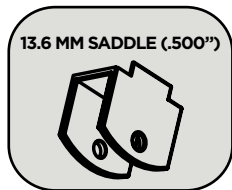

SADDLE WINDSHIELD WIPERS



FEATURES & BENEFITS

- All-metal, stainless steel, riveted frame
- Dual stainless steel spline
- Molded, chlorinated rubber for longer life
- Approved by major transit authorities

SPECIFICATIONS

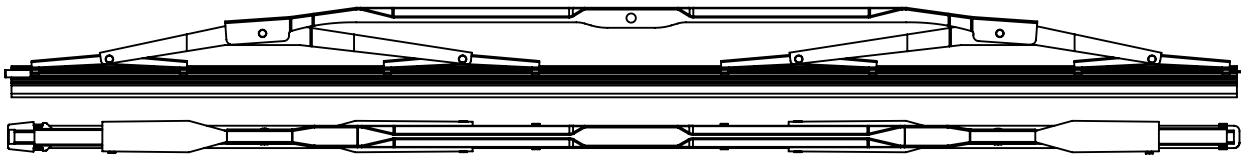

ALLIANCE P/N	ANCO	
	BLACK	SILVER
ABP N82 13226	52-27	52-26
ABP N82 13228	-	-

COMMON APPLICATIONS

- Transit buses

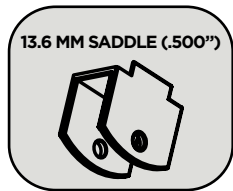

WINDSHIELD WIPERS WINTER WIPERS

4



WINTER WINDSHIELD WIPERS

4

HOOK & PIN WINTER WIPER BLADES

FEATURES & BENEFITS

- Rubber boot prevents snow and ice build-up
- Natural molded rubber for longer life
- Riveted joints for a more durable frame
- High quality in all seasons

SPECIFICATIONS

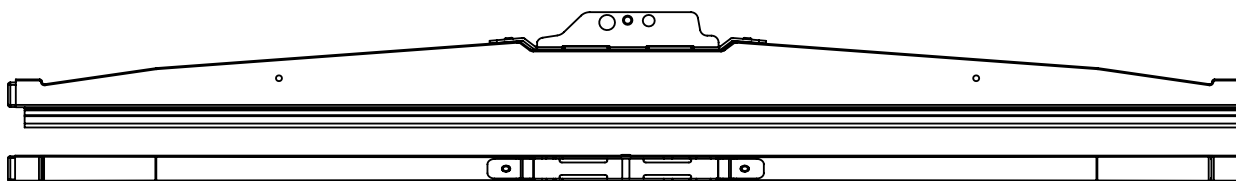

ALLIANCE P/N	ANCO	TRICO
ABP N82 W13	-	-
ABP N82 W15	-	-
ABP N82 W16	30-16	37-160
ABP N82 W18	30-18	37-180
ABP N82 W20	30-20	37-205
ABP N82 W22	30-22	37-225
ABP N82 W24	30-24	37-245
ABP N82 W26	-	-
ABP N82 W28	-	-

COMMON APPLICATIONS

- Passenger cars and trucks
- Class 6, 7 and 8 trucks
- School buses
- Class C RVs
- Specialty vehicles

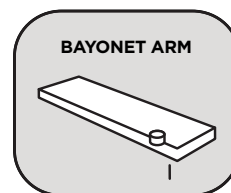
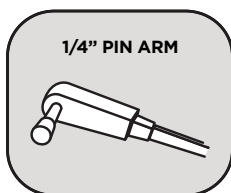

WINTER WINDSHIELD WIPERS

FEATURES & BENEFITS

- Rubber boot prevents snow and ice build-up
- Natural molded rubber for longer life
- Riveted joints for a more durable frame
- High quality in all seasons

SPECIFICATIONS

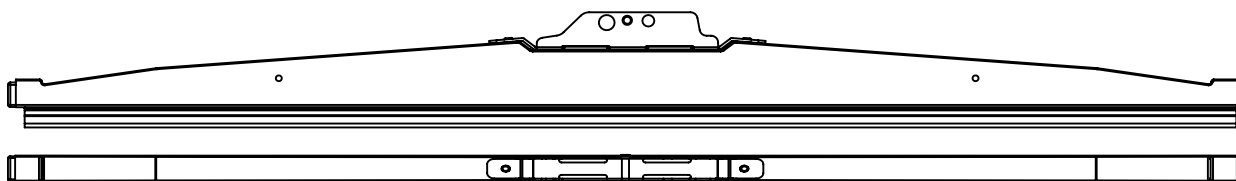

ALLIANCE P/N	ANCO	TRICO
ABP N82 WN13	-	-
ABP N82 WN15	-	-
ABP N82 WN16	59-16	66-160
ABP N82 WN18	59-18	66-180
ABP N82 WN20	59-20	66-200
ABP N82 WN22	59-22	66-220
ABP N82 WN24	59-24	66-240
ABP N82 WN26	-	-
ABP N82 WN28	-	-

COMMON APPLICATIONS

- Heavy-duty trucks
- Old-model school buses
- Airport ground equipment
- Postal vehicles
- Old-model refuse trucks
- Specialty vehicles



NOTES

WINDSHIELD WIPER MOTORS

5



WINDSHIELD WIPER MOTORS

FEATURES & BENEFITS

- Wiring Harness included with each motor
- Necessary brackets and hardware included with each motor
- Motor, hardware and bracket are designed for OEM Replacement

SPECIFICATIONS



ALLIANCE P/N	OEM P/N	APPLICATIONS
ABP N82 AX9103	33QT521M	Mack CH
ABP N82 AX9104	63QT311	Mack MR post 2007
ABP N82 AX9104	62QT311	Mack RD
ABP N82 AX9108	8065756	Mack MR pre 2007
ABP N82 AX9108	8065756	Am Tran Bus
ABP N82 AX9109	V3DC1	Kenworth T300, T600
ABP N82 AX9111	04304440	Blue Bird post 2006
ABP N82 AX9111	04304440	Thomas Bus (1973-present)
ABP N82 AX9112	10102238	Blue Bird post 2006
ABP N82 AX9204	1999-3110010	Freightliner FLD
ABP N82 AX9204	1999-3110010	Western Star post 2000
ABP N82 AX9207	E005-554	Kenworth T2000, W900, T800
ABP N82 AX9207	E005-554	Peterbilt 387 Series
ABP N82 AX9208	628163404	Western Star pre 2000
ABP N82 AX9213	8169B28	USPS LLV Model
ABP N82 AX9310	SPR/FL80	Freightliner Business Class (all)

WINDSHIELD WIPER MOTORS

FEATURES & BENEFITS

- Self-contained, oscillating shaft requires no external linkage
- Parts exposed to weather are corrosion- and water-resistant
- The wipe angle can be adjusted by removing the gear cover box and moving the lever plate pin to the correctly labeled hole

SPECIFICATIONS

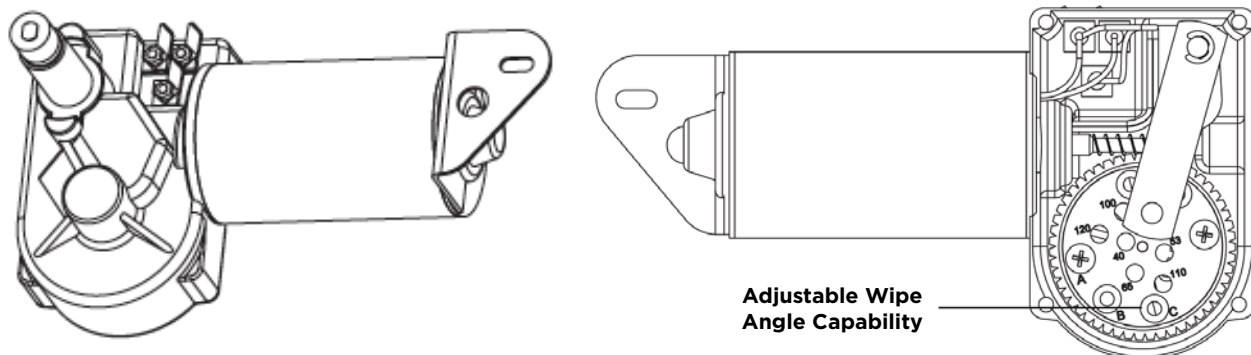

4R SELF-CONTAINED WIPER MOTORS			
ALLIANCE P/N	VOLTS	SHAFT LENGTH	WIPE ANGLE
4R1.12.R110D	12	1"	110°
4R2.12.R110D	12	2"	110°
4R3.12.R110D	12	3"	110°
4R1.24.R110D	24	1"	110°
4R2.24.R110D	24	2"	110°
4R3.24.R110D	24	3"	110°

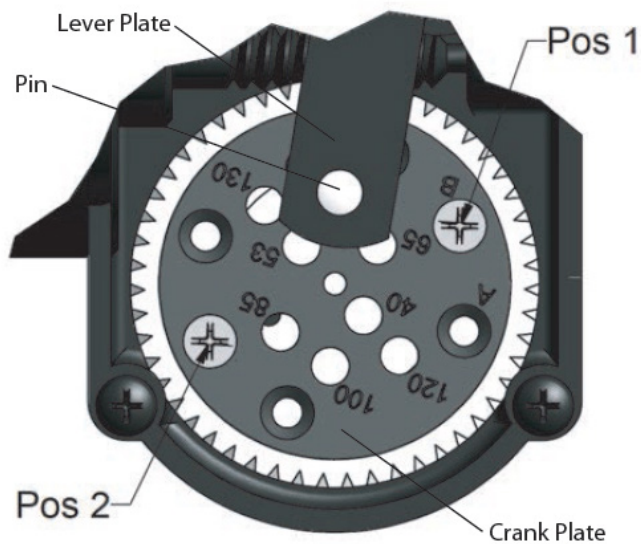

Angle/Park	Hole	Pos.
40/R	C	2
40/L	C	1
53/R	C	1
53/L	C	2
65/R	A	1
65/L	A	2
85/R	A	2
85/L	A	1
100/R	B	2
100/L	B	1
110/R	B	1
110/L	B	2

INSTALLATION & MAINTENANCE

6



COMMON WIPER PROBLEMS

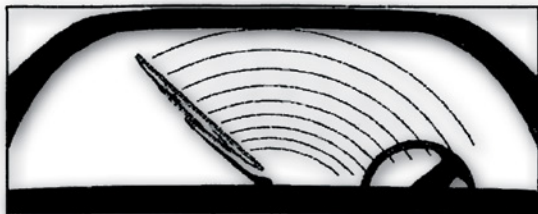

STREAKING



MISSED WIPE AREAS

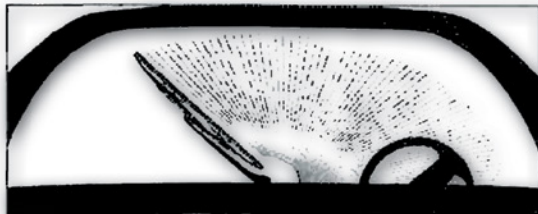

SMEARING

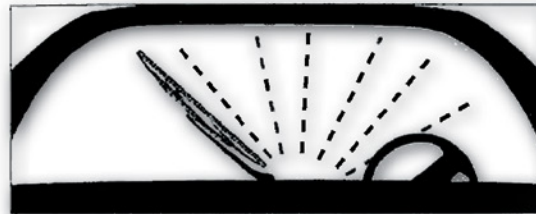

CHATTERING

CAUSES OF PROBLEMS



STREAKING



SMEARING



MISSED WIPE AREAS



CHATTERING

UNIVERSAL WIPER INSTALLATION INSTRUCTIONS

9x3"/9x4" HOOK - GANCHO

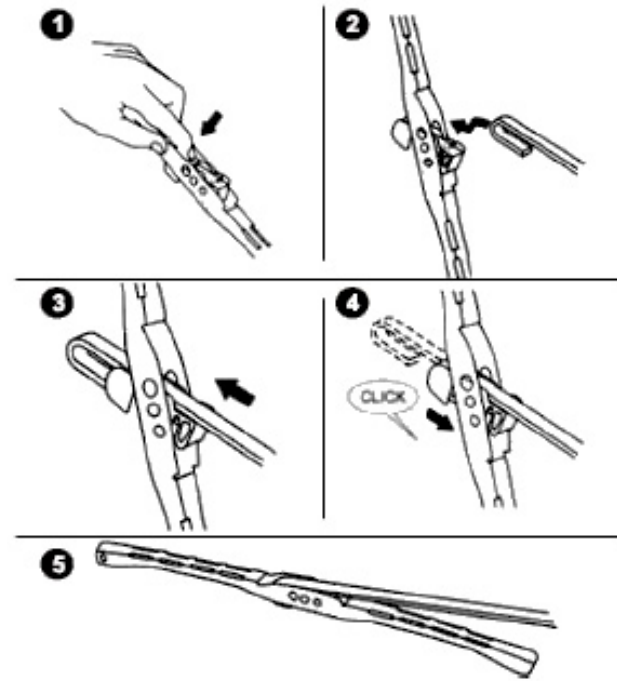

1/4" 3/16" PIN - PERNO

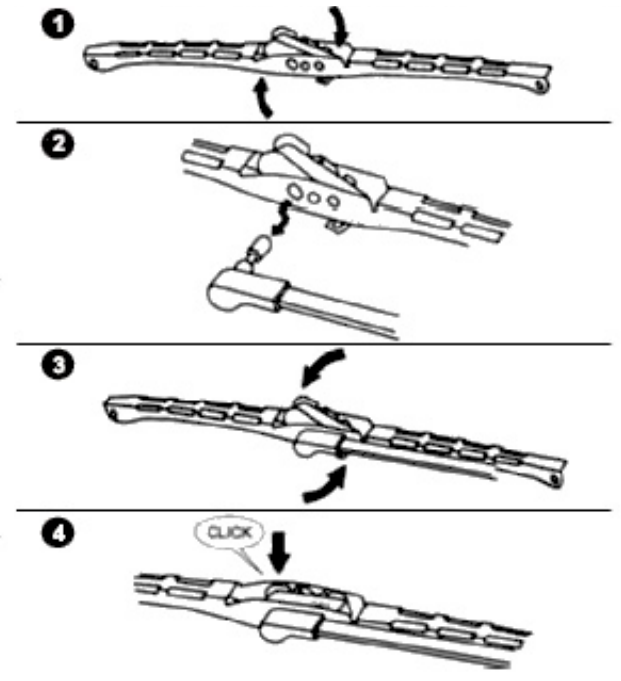

SADDLE WIPER INSTALLATION INSTRUCTIONS

6

SADDLE WIPER INSTALLATION INSTRUCTIONS

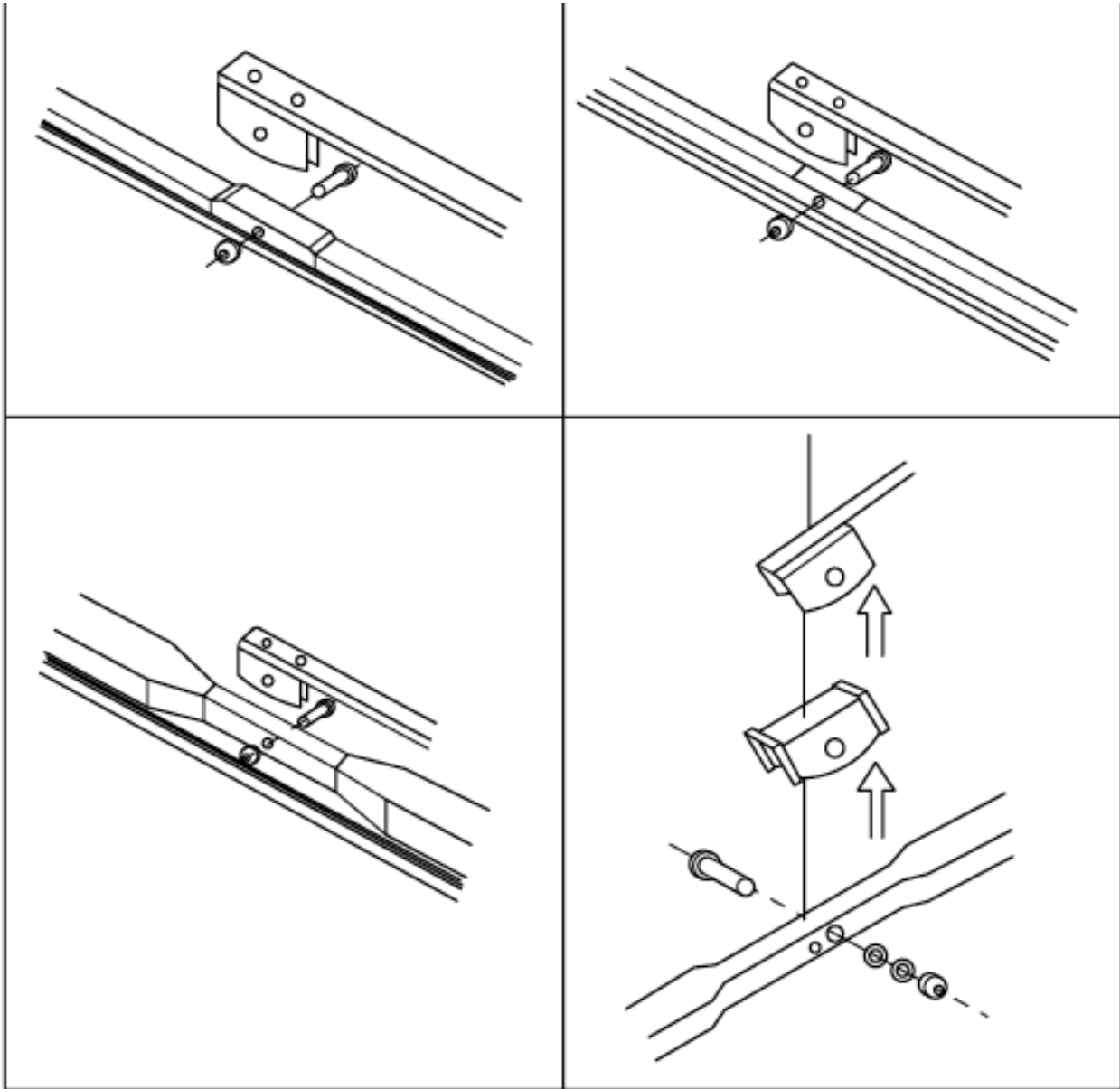

CROSS-REFERENCE

7



CROSS-REFERENCE

7

CROSS-REFERENCE

ANCO	
COMP. P/N	ALLIANCE P/N
30-16	ABP N82 W16
30-18	ABP N82 W18
30-20	ABP N82 W20
30-22	ABP N82 W22
30-24	ABP N82 W24
31-15	ABP N82 7515
31-16	ABP N82 7516
31-17	ABP N82 7517
31-18	ABP N82 7518
31-19	ABP N82 7519
31-20	ABP N82 7520
31-21	ABP N82 7521
31-22	ABP N82 7522
31-24	ABP N82 7524
50-20	ABP N82 7420
50-22	ABP N82 7422
50-24	ABP N82 7724
50-26	ABP N82 7726
50-28	ABP N82 7728
50-32	ABP N82 7732
51-11	ABP N82 7111
51-12	ABP N82 7112
51-13	ABP N82 7113
51-14	ABP N82 7114
51-15	ABP N82 7115
51-16	ABP N82 7116
51-17	ABP N82 7117
51-18	ABP N82 7118
51-19	ABP N82 7119
51-20	ABP N82 7120
51-21	ABP N82 7121
51-22	ABP N82 7122
52-15	ABP N82 7215
52-16	ABP N82 7216
52-18	ABP N82 7218
52-20	ABP N82 7220
52-22	ABP N82 7222
52-24	ABP N82 7224
52-26	ABP N82 13226

ANCO	
COMP. P/N	ALLIANCE P/N
52-27	ABP N82 13226
57-08	ABP N82 7216
57-09	ABP N82 7218
57-10	ABP N82 7220
57-18	ABP N82 13718
59-16	ABP N82 WN16
59-18	ABP N82 WN18
59-20	ABP N82 WN20
59-22	ABP N82 WN22
59-24	ABP N82 WN24
91-12	ABP N82 7612
91-13	ABP N82 7613
91-14	ABP N82 7614
91-15	ABP N82 7615
91-16	ABP N82 7616
91-17	ABP N82 7617
91-18	ABP N82 7618
91-19	ABP N82 7619
91-20	ABP N82 7620
91-21	ABP N82 7621
91-22	ABP N82 7622
91-24	ABP N82 7624
91-26	ABP N82 7626
91-28	ABP N82 7628

TRICO	
COMP. P/N	ALLIANCE P/N
12-2	ABP N82 7512
13-1	ABP N82 7513
14-1	ABP N82 7514
14-2	ABP N82 7514
15-1	ABP N82 7515
15-130	ABP N82 7613
15-140	ABP N82 7614
15-150	ABP N82 7615
15-160	ABP N82 7616
15-170	ABP N82 7617
15-180	ABP N82 7618

CROSS-REFERENCE

TRICO	
COMP. P/N	ALLIANCE P/N
15-190	ABP N82 7619
15-200	ABP N82 7620
15-210	ABP N82 7621
15-220	ABP N82 7622
15-240	ABP N82 7624
15-260	ABP N82 7626
15-280	ABP N82 7628
16-1	ABP N82 7516
16-2	ABP N82 7516
17-1	ABP N82 7517
17-2	ABP N82 7517
18-1	ABP N82 7518
18-2	ABP N82 7518
19-1	ABP N82 7519
19-2	ABP N82 7519
19-3	ABP N82 7519
19-7	ABP N82 7519
19-9	ABP N82 7519
20-1	ABP N82 7520
20-2	ABP N82 7520
20-4	ABP N82 7520
20-9	ABP N82 7520
21-1	ABP N82 7521
21-9	ABP N82 7521

AUTOMOTIVE APPLICATION GUIDE

8



AUTOMOTIVE APPLICATION GUIDE



START	END	MAKE	MODEL	DS	PS	TYPE
1996	1999	ACURA	CL	24"	20"	Metal
2000	2003	ACURA	CL	24"	18"	Metal
2013	2013	ACURA	ILX	26"	19"	Beam
1986	1989	ACURA	INTEGRA	18"	18"	Metal
1990	1993	ACURA	INTEGRA	20"	18"	Metal
1994	2001	ACURA	INTEGRA	22"	18"	Metal
1986	1992	ACURA	LEGEND	20"	19"	Metal
1993	1995	ACURA	LEGEND	22"	19"	Metal
2001	2006	ACURA	MDX	24"	21"	Metal
2007	2012	ACURA	MDX	26"	21"	Metal
1991	2005	ACURA	NSX	22"	22"	Metal
2007	2013	ACURA	RDX	26"	16"	Beam
1996	2004	ACURA	RL	22"	19"	Metal
2002	2006	ACURA	RSX	24"	20"	Metal
1996	1998	ACURA	SLX	20"	20"	Metal
1995	2003	ACURA	TL	24"	19"	Metal
2004	2008	ACURA	TL	26"	19"	Metal
2009	2013	ACURA	TL	26"	19"	Metal
2004	2005	ACURA	TSX	26"	16"	Metal
2005	2008	ACURA	TSX	24"	16"	Beam
2009	2012	ACURA	TSX	24"	22"	Beam
1992	1994	ACURA	VIGOR	24"	19"	Metal
2010	2012	ACURA	ZDX	24"	19"	Beam
1991	1993	ALFA ROMEO	ALFA 164	21"	21"	Metal
1994	1995	ALFA ROMEO	ALFA 164	21"	21"	Metal
1986	1994	ALFA ROMEO	SPIDER	17"	17"	Metal
1989	1991	AUDI	100, 200	21"	21"	Metal
1992	1995	AUDI	100, 200	22"	22"	Metal
1985	1987	AUDI	4000, 4000S QUATTRO	21"	21"	Metal
1984	1988	AUDI	5000, CS, S, QUATTRO	21"	21"	Metal
1988	1992	AUDI	80, 90	21"	21"	Metal
1993	1995	AUDI	90	21"	21"	Metal
2006	2012	AUDI	A3	22"	20"	Beam
1996	2008	AUDI	A4/S4	21"	21"	Metal
2009	2013	AUDI	A4/S4	24"	20"	Beam
2009	2013	AUDI	A5	24"	20"	Beam
1995	2004	AUDI	A6/S6	22"	22"	Metal
2005	2013	AUDI	A6/S6	26"	21"	Beam
2012	2013	AUDI	A7	24"	21"	Beam
1995	2001	AUDI	A8	22"	22"	Metal
2004	2013	AUDI	A8	26"	20"	Beam

AUTOMOTIVE APPLICATION GUIDE

START	END	MAKE	MODEL	DS	PS	TYPE
2001	2004	AUDI	ALLROAD QUATTRO	22"	22"	Metal
1995	1998	AUDI	CABRIOLET	22"	22"	Metal
1985	1987	AUDI	COUPE	21"	21"	Metal
1990	1991	AUDI	COUPE	22"	22"	Metal
2010	2012	AUDI	Q5	24"	20"	Beam
2007	2012	AUDI	Q7	26"	26"	Beam
2008	2012	AUDI	R8	22"	24"	Beam
2000	2004	AUDI	TT	21"	21"	Metal
2005	2013	AUDI	TT	21"	21"	Beam
1990	1991	AUDI	V8	21"	21"	Metal
1992	1994	AUDI	V8	22"	22"	Metal
1963	1990	AVANTI	ALL MODELS	15"	15"	Metal
2008	2012	BMW	1-SERIES	20"	20"	Beam
1992	1998	BMW	3-SERIES (EXCEPT 325 CONVERTIBLE)	21"	20"	Metal
1999	2003	BMW	3-SERIES (EXCEPT 328)	22"	20"	Metal
2004	2013	BMW	3-SERIES COUPE/CONVERTIBLE	24"	18"	Beam
2004	2013	BMW	3-SERIES SEDAN	24"	19"	Beam
1983	1991	BMW	318i, 318is	20"	20"	Metal
1984	1991	BMW	325	20"	20"	Metal
1994	1996	BMW	325 CONVERTIBLE	24"	20"	Metal
1982	1988	BMW	5-SERIES	18"	18"	Metal
1989	1996	BMW	5-SERIES	24"	24"	Metal
1997	2003	BMW	5-SERIES	26"	22"	Metal
2004	2009	BMW	5-SERIES	24"	22"	Beam
2010	2012	BMW	5-SERIES	26"	18"	Beam
1979	2005	BMW	6-SERIES	18"	18"	Metal
2006	2010	BMW	6-SERIES	24"	22"	Beam
2011	2012	BMW	6-SERIES	26"	17"	Beam
1979	1987	BMW	7-SERIES	18"	18"	Metal
1993	2001	BMW	7-SERIES	22"	24"	Metal
2002	2012	BMW	7-SERIES	26"	19"	Beam
2004	2010	BMW	X3	22"	20"	Metal
2011	2012	BMW	X3	26"	20"	Beam
1999	2006	BMW	X5	24"	22"	Metal
2007	2013	BMW	X5	24"	20"	Beam
2009	2012	BMW	X6	24"	20"	Beam
1996	2001	BMW	Z3	20"	20"	Metal
2003	2012	BMW	Z4	21"	20"	Metal
1984	1996	BUICK	CENTURY	18"	18"	Metal
1997	2005	BUICK	CENTURY	22"	22"	Metal
1985	1990	BUICK	ELECTRA	19"	19"	Metal

AUTOMOTIVE APPLICATION GUIDE

START	END	MAKE	MODEL	DS	PS	TYPE
1991	1994	BUICK	ELECTRA	22"	22"	Metal
2008	2012	BUICK	ENCLAVE	24"	21"	Beam
1970	1990	BUICK	ESTATE WAGON	18"	18"	Metal
2005	2009	BUICK	LA CROSSE	22"	22"	Beam
2010	2013	BUICK	LA CROSSE	26"	18"	Beam
1986	1991	BUICK	LE SABRE	19"	19"	Metal
1992	1996	BUICK	LE SABRE	22"	22"	Metal
1997	2005	BUICK	LE SABRE	22"	22"	Metal
2006	2011	BUICK	LUCERNE	24"	21"	Beam
1985	1990	BUICK	PARK AVE	19"	19"	Metal
1991	1996	BUICK	PARK AVE	22"	22"	Metal
1997	2005	BUICK	PARK AVE	22"	22"	Metal
2004	2006	BUICK	RAINIER	22"	22"	Metal
2007	2008	BUICK	RAINIER	22"	22"	Metal
1988	1991	BUICK	REATA	19"	19"	Metal
1978	1987	BUICK	REGAL	18"	18"	Metal
1988	1996	BUICK	REGAL	20"	20"	Metal
1997	2010	BUICK	REGAL	22"	22"	Metal
2011	2013	BUICK	REGAL	24"	18"	Beam
2002	2007	BUICK	RENDEZVOUS	24"	22"	Metal
1986	1993	BUICK	RIVIERA	19"	19"	Metal
1994	2000	BUICK	RIVIERA	22"	22"	Metal
1991	1996	BUICK	ROADMASTER	22"	22"	Metal
1975	1989	BUICK	SKYHAWK	16"	16"	Metal
1986	1997	BUICK	SKYLARK	19"	19"	Metal
1985	1988	BUICK	SOMERSET	19"	19"	Metal
2005	2007	BUICK	TERRAZA	24"	22"	Metal
1998	1998	BUICK	ULTRA	22"	22"	Metal
2012	2012	BUICK	VERANO	26"	24"	Beam
1987	1993	CADILLAC	ALLANTE	19"	19"	Metal
1997	2001	CADILLAC	CATERA	24"	19"	Metal
1982	1988	CADILLAC	CIMARRON	16"	16"	Metal
1995	2000	CADILLAC	CONCOURS	22"	22"	Metal
2003	2007	CADILLAC	CTS	22"	21"	Metal
2008	2013	CADILLAC	CTS	22"	19"	Beam
2010	2012	CADILLAC	CTS-V	22"	19"	Metal
1998	1998	CADILLAC	D'ELEGANCE	22"	22"	Metal
1985	1990	CADILLAC	DEVILLE	19"	19"	Metal
1991	2005	CADILLAC	DEVILLE	22"	22"	Metal
2006	2011	CADILLAC	DTS	22"	22"	Beam
1986	1991	CADILLAC	ELDORADO	19"	19"	Metal

AUTOMOTIVE APPLICATION GUIDE

START	END	MAKE	MODEL	DS	PS	TYPE
1992	2002	CADILLAC	ELDORADO	22"	22"	Metal
1999	2001	CADILLAC	ESCALADE	18"	18"	Metal
2002	2006	CADILLAC	ESCALADE	22"	22"	Metal
2007	2007	CADILLAC	ESCALADE	22"	22"	Beam
2008	2008	CADILLAC	ESCALADE	22"	22"	Metal
2009	2013	CADILLAC	ESCALADE	22"	22"	Metal
1998	1998	CADILLAC	FLEETWOOD	22"	22"	Metal
1985	1992	CADILLAC	FLEETWOOD-FWD	19"	19"	Metal
1993	1995	CADILLAC	FLEETWOOD-FWD	22"	22"	Metal
1985	1992	CADILLAC	FLEETWOOD-RWD	18"	18"	Metal
1993	1994	CADILLAC	FLEETWOOD-RWD	22"	22"	Metal
1986	1991	CADILLAC	SEVILLE	19"	19"	Metal
1992	1997	CADILLAC	SEVILLE	22"	22"	Metal
1998	2004	CADILLAC	SEVILLE	22"	22"	Metal
2004	2009	CADILLAC	SRX	22"	21"	Metal
2010	2012	CADILLAC	SRX	26"	17"	Beam
2005	2011	CADILLAC	STS	22"	21"	Beam
2004	2009	CADILLAC	XLR	22"	22"	Metal
1985	2005	CHEVROLET	ASTRO	18"	18"	Metal
2002	2013	CHEVROLET	AVALANCHE	22"	22"	Metal
2007	2008	CHEVROLET	AVALANCHE	22"	22"	Beam
2004	2011	CHEVROLET	AVEO	22"	19"	Metal
2008	2011	CHEVROLET	AVEO-5 DOOR	22"	18"	Metal
1987	1989	CHEVROLET	BERETTA	19"	19"	Metal
1990	1996	CHEVROLET	BERETTA	19"	19"	Metal
1985	1991	CHEVROLET	BLAZER	16"	16"	Metal
1992	1994	CHEVROLET	BLAZER	18"	18"	Metal
1995	2005	CHEVROLET	BLAZER	20"	20"	Metal
1983	1994	CHEVROLET	BLAZER (S-10 TYPE)	16"	16"	Metal
1973	1987	CHEVROLET	C/K-SERIES PICKUP	16"	16"	Metal
1988	2000	CHEVROLET	C/K-SERIES PICKUP	18"	18"	Metal
1977	1992	CHEVROLET	CAMARO	18"	18"	Metal
1993	2001	CHEVROLET	CAMARO	24"	24"	Metal
2010	2012	CHEVROLET	CAMARO	24"	21"	Beam
1971	1990	CHEVROLET	CAPRICE	18"	18"	Metal
1991	1996	CHEVROLET	CAPRICE	22"	22"	Metal
2012	2012	CHEVROLET	CAPTIVA SPORT	24"	16"	Metal
1982	1989	CHEVROLET	CAVALIER	16"	16"	Metal
1990	1994	CHEVROLET	CAVALIER	17"	17"	Metal
1995	2005	CHEVROLET	CAVALIER	22"	17"	Metal
1984	1990	CHEVROLET	CELEBRITY	18"	18"	Metal

AUTOMOTIVE APPLICATION GUIDE

00

AUTOMOTIVE APPLICATION GUIDE

START	END	MAKE	MODEL	DS	PS	TYPE
1976	1987	CHEVROLET	CHEVETTE	16"	16"	Metal
2005	2010	CHEVROLET	COBALT	22"	17"	Metal
2004	2012	CHEVROLET	COLORADO	22"	19"	Metal
1987	1996	CHEVROLET	CORSICA	19"	19"	Metal
1984	1997	CHEVROLET	CORVETTE	20"	20"	Metal
1998	2004	CHEVROLET	CORVETTE	22"	22"	Metal
2005	2013	CHEVROLET	CORVETTE	21"	21"	Metal
2011	2013	CHEVROLET	CRUZE	24"	17"	Metal
1978	1987	CHEVROLET	EL CAMINO	18"	18"	Metal
2005	2009	CHEVROLET	EQUINOX	24"	19"	Metal
2010	2013	CHEVROLET	EQUINOX	24"	17"	Beam
1996	2012	CHEVROLET	EXPRESS	22"	22"	Metal
2006	2011	CHEVROLET	HHR	18"	18"	Beam
1971	1993	CHEVROLET	IMPALA	18"	18"	Metal
1994	2005	CHEVROLET	IMPALA	22"	22"	Metal
2006	2013	CHEVROLET	IMPALA	22"	22"	Beam
1990	1996	CHEVROLET	LUMINA APV	24"	24"	Metal
1990	1994	CHEVROLET	LUMINA SEDAN	20"	20"	Metal
1995	2000	CHEVROLET	LUMINA SEDAN	22"	22"	Metal
1978	1996	CHEVROLET	MALIBU	18"	18"	Metal
1997	2003	CHEVROLET	MALIBU	22"	19"	Metal
2008	2012	CHEVROLET	MALIBU	24"	21"	Beam
2013	2013	CHEVROLET	MALIBU	24"	19"	Beam
2004	2007	CHEVROLET	MALIBU/MAXX	22"	20"	Metal
2004	2005	CHEVROLET	MALIBU CLASSIC	22"	19"	Metal
1998	2001	CHEVROLET	METRO	20"	19"	Metal
1978	1994	CHEVROLET	MONTE CARLO	18"	18"	Metal
1995	1997	CHEVROLET	MONTE CARLO	22"	22"	Metal
1998	2005	CHEVROLET	MONTE CARLO	22"	19"	Metal
2006	2007	CHEVROLET	MONTE CARLO	22"	22"	Beam
1985	1988	CHEVROLET	NOVA	17"	17"	Metal
1998	2001	CHEVROLET	PRIZM	20"	18"	Metal
1982	1993	CHEVROLET	S/T-SERIES PICKUP	16"	16"	Metal
1994	2004	CHEVROLET	S/T-SERIES PICKUP	20"	20"	Metal
1999	2006	CHEVROLET	SILVERADO	22"	22"	Metal
2007	2012	CHEVROLET	SILVERADO	22"	22"	Beam
2007	2007	CHEVROLET	SILVERADO CLASSIC	22"	22"	Metal
2012	2012	CHEVROLET	SONIC	26"	15"	Beam
1985	1988	CHEVROLET	SPECTRUM	17"	17"	Metal
1985	1988	CHEVROLET	SPRINT	17"	17"	Metal
2004	2006	CHEVROLET	SSR	20"	19"	Metal

AUTOMOTIVE APPLICATION GUIDE

START	END	MAKE	MODEL	DS	PS	TYPE
1973	1991	CHEVROLET	SUBURBAN	16"	16"	Metal
1992	1994	CHEVROLET	SUBURBAN	18"	18"	Metal
1995	1999	CHEVROLET	SUBURBAN	18"	18"	Metal
2000	2006	CHEVROLET	SUBURBAN	22"	22"	Metal
2007	2008	CHEVROLET	SUBURBAN	22"	22"	Beam
2009	2013	CHEVROLET	SUBURBAN	22"	22"	Metal
1995	1999	CHEVROLET	TAHOE	18"	18"	Metal
2000	2006	CHEVROLET	TAHOE	22"	22"	Metal
2007	2008	CHEVROLET	TAHOE	22"	22"	Beam
2009	2013	CHEVROLET	TAHOE	22"	22"	Metal
1998	2003	CHEVROLET	TRACKER	15"	15"	Metal
2004	2004	CHEVROLET	TRACKER	19"	19"	Metal
2002	2006	CHEVROLET	TRAILBLAZER	22"	22"	Metal
2007	2009	CHEVROLET	TRAILBLAZER	22"	22"	Metal
2009	2012	CHEVROLET	TRAVERSE	24"	21"	Beam
2005	2008	CHEVROLET	UPLANDER	24"	22"	Metal
1964	1989	CHEVROLET	VAN (G-SERIES)	16"	16"	Metal
1990	1995	CHEVROLET	VAN (G-SERIES)	18"	18"	Metal
1996	2002	CHEVROLET	VAN (G-SERIES, EXPRESS)	22"	22"	Metal
1997	2005	CHEVROLET	VENTURE	24"	24"	Metal
2011	2012	CHEVROLET	VOLT	26"	26"	Beam
2011	2012	CHRYSLER	200	24"	22"	Beam
2005	2010	CHRYSLER	300	22"	22"	Metal
2011	2013	CHRYSLER	300	24"	21"	Beam
1999	2004	CHRYSLER	300-M	24"	22"	Metal
2007	2009	CHRYSLER	ASPEN	26"	21"	Metal
1996	2000	CHRYSLER	CIRRUS	22"	22"	Metal
1993	1994	CHRYSLER	CONCORDE	24"	22"	Metal
1995	1996	CHRYSLER	CONCORDE	24"	24"	Metal
1997	2004	CHRYSLER	CONCORDE	24"	22"	Metal
1987	1989	CHRYSLER	CONQUEST	19"	19"	Metal
2003	2008	CHRYSLER	CROSSFIRE	20"	22"	Metal
1983	1988	CHRYSLER	E CLASS	16"	16"	Metal
1983	1993	CHRYSLER	FIFTH AVE	18"	18"	Metal
1981	1988	CHRYSLER	IMPERIAL	18"	18"	Metal
1989	1993	CHRYSLER	IMPERIAL	18"	18"	Metal
1993	1994	CHRYSLER	LHS	24"	22"	Metal
1995	1997	CHRYSLER	LHS	24"	24"	Metal
1998	2002	CHRYSLER	LHS	24"	22"	Metal
1989	1993	CHRYSLER	LEBARON	18"	18"	Metal
1994	2005	CHRYSLER	LEBARON CONVERTIBLE	19"	19"	Metal

AUTOMOTIVE APPLICATION GUIDE

00

AUTOMOTIVE APPLICATION GUIDE

START	END	MAKE	MODEL	DS	PS	TYPE
1994	1994	CHRYSLER	LEBARON COUPE	18"	18"	Metal
1987	1988	CHRYSLER	LEBARON COUPE, CONVERTIBLE	18"	18"	Metal
1984	1989	CHRYSLER	LEBARON GTS	18"	18"	Metal
1987	1988	CHRYSLER	LEBARON SEDAN	16"	16"	Metal
1983	1988	CHRYSLER	NEW YORKER	16"	16"	Metal
1989	1993	CHRYSLER	NEW YORKER	18"	18"	Metal
1993	1994	CHRYSLER	NEW YORKER	24"	22"	Metal
1995	1996	CHRYSLER	NEW YORKER	24"	24"	Metal
2004	2008	CHRYSLER	PACIFICA	22"	22"	Metal
2001	2010	CHRYSLER	PT CRUISER	19"	21"	Metal
1996	2006	CHRYSLER	SEBRING CONVERTIBLE	22"	22"	Metal
2007	2010	CHRYSLER	SEBRING CONVERTIBLE	22"	22"	Beam
1995	2000	CHRYSLER	SEBRING COUPE	24"	22"	Metal
2001	2005	CHRYSLER	SEBRING COUPE	24"	21"	Metal
2001	2006	CHRYSLER	SEBRING SEDAN	22"	22"	Metal
2007	2010	CHRYSLER	SEBRING SEDAN	24"	22"	Beam
1989	1991	CHRYSLER	TC	18"	18"	Metal
1990	1990	CHRYSLER	TOWN & COUNTRY	18"	18"	Metal
1991	1992	CHRYSLER	TOWN & COUNTRY	18"	18"	Metal
1993	1994	CHRYSLER	TOWN & COUNTRY	22"	18"	Metal
1995	1995	CHRYSLER	TOWN & COUNTRY	22"	22"	Metal
1996	2007	CHRYSLER	TOWN & COUNTRY	28"	28"	Metal
2008	2013	CHRYSLER	TOWN & COUNTRY	26"	20"	Metal
2000	2003	CHRYSLER	VOYAGER, GRAND VOYAGER	28"	28"	Metal
1999	2001	DAEWOO	LANOS	19"	19"	Metal
1999	2001	DAEWOO	LEGANZA	22"	19"	Metal
1999	2001	DAEWOO	NUBIRA	20"	20"	Metal
1988	1992	DAIHATSU	CHARADE	18"	18"	Metal
1990	1992	DAIHATSU	ROCKY	16"	16"	Metal
1982	1988	DODGE	400, 600	16"	16"	Metal
1981	1990	DODGE	AIRES	16"	16"	Metal
1996	1996	DODGE	AVENGER	22"	22"	Metal
1997	2006	DODGE	AVENGER	24"	22"	Metal
2007	2013	DODGE	AVENGER	24"	22"	Beam
2006	2012	DODGE	CALIBER	24"	17"	Metal
2009	2012	DODGE	CHALLENGER	22"	22"	Metal
1982	1987	DODGE	CHARGER	16"	16"	Metal
2005	2010	DODGE	CHARGER	22"	22"	Metal
2011	2012	DODGE	CHARGER	24"	21"	Beam
1985	1990	DODGE	COLT	19"	17"	Metal
1991	1992	DODGE	COLT	20"	17"	Metal

AUTOMOTIVE APPLICATION GUIDE

START	END	MAKE	MODEL	DS	PS	TYPE
1993	1994	DODGE	COLT	20"	18"	Metal
1985	1988	DODGE	COLT HATCHBACK	19"	17"	Metal
1984	1990	DODGE	COLT VISTA	19"	17"	Metal
1985	1990	DODGE	COLT WAGON	19"	17"	Metal
1984	1987	DODGE	CONQUEST	19"	19"	Metal
1987	1993	DODGE	D-50, RAM 50	17"	17"	Metal
1987	1996	DODGE	DAKOTA	18"	18"	Metal
1997	2004	DODGE	DAKOTA	20"	20"	Metal
2005	2011	DODGE	DAKOTA	21"	21"	Metal
1984	1993	DODGE	DAYTONA	18"	18"	Metal
1977	1989	DODGE	DIPLOMAT	18"	18"	Metal
1998	2003	DODGE	DURANGO	20"	20"	Metal
2004	2009	DODGE	DURANGO	26"	21"	Metal
2011	2013	DODGE	DURANGO	22"	21"	Metal
1988	1993	DODGE	DYNASTY	18"	18"	Metal
1990	1990	DODGE	GRAND CARAVAN & CARAVAN	18"	18"	Metal
1991	1992	DODGE	GRAND CARAVAN & CARAVAN	18"	18"	Metal
1993	1994	DODGE	GRAND CARAVAN & CARAVAN	22"	18"	Metal
1995	1995	DODGE	GRAND CARAVAN & CARAVAN	22"	22"	Metal
1996	2007	DODGE	GRAND CARAVAN & CARAVAN	28"	28"	Metal
2008	2013	DODGE	GRAND CARAVAN & CARAVAN	26"	20"	Metal
1993	1994	DODGE	INTREPID	24"	22"	Metal
1995	1996	DODGE	INTREPID	24"	24"	Metal
1997	2004	DODGE	INTREPID	24"	22"	Metal
2008	2012	DODGE	JOURNEY	24"	19"	Metal
1985	1989	DODGE	LANCER	18"	18"	Metal
2005	2008	DODGE	MAGNUM	22"	22"	Metal
1990	1992	DODGE	MONACO	20"	20"	Metal
1995	1999	DODGE	NEON	21"	18"	Metal
2000	2005	DODGE	NEON	22"	19"	Metal
2007	2012	DODGE	NITRO	19"	19"	Metal
1978	1990	DODGE	OMNI	16"	16"	Metal
1972	1987	DODGE	PICKUP, FULL SIZE	18"	18"	Metal
1988	1993	DODGE	PICKUP, FULL SIZE	18"	18"	Metal
1994	2001	DODGE	PICKUP, FULL SIZE (RAM)	20"	20"	Metal
2002	2009	DODGE	PICKUP, FULL SIZE (RAM)	24"	24"	Metal
2010	2013	DODGE	PICKUP, FULL SIZE (RAM)	22"	22"	Metal
1987	1990	DODGE	RAIDER	16"	16"	Metal
1974	1993	DODGE	RAM CHARGER	18"	18"	Metal
2003	2003	DODGE	RAM HD	24"	24"	Metal
1999	1999	DODGE	RAM WAGON	18"	18"	Metal

AUTOMOTIVE APPLICATION GUIDE

00

AUTOMOTIVE APPLICATION GUIDE

START	END	MAKE	MODEL	DS	PS	TYPE
1987	1994	DODGE	SHADOW	18"	18"	Metal
1989	1994	DODGE	SPIRIT	18"	18"	Metal
2003	2007	DODGE	SPRINTER	24"	22"	Metal
2008	2011	DODGE	SPRINTER	26"	24"	Beam
1991	1994	DODGE	STEALTH	21"	20"	Metal
1996	2006	DODGE	STRATUS	22"	22"	Metal
2001	2005	DODGE	STRATUS COUPE	24"	21"	Metal
1976	1995	DODGE	VAN-FULL SIZE	16"	16"	Metal
1996	2003	DODGE	VAN-FULL SIZE	18"	18"	Metal
1993	2004	DODGE	VIPER	16"	16"	Metal
1988	1989	EAGLE	MEDALLION	20"	20"	Metal
1988	1992	EAGLE	PREMIER	20"	20"	Metal
1989	1991	EAGLE	SUMMIT	19"	17"	Metal
1992	1994	EAGLE	SUMMIT SEDAN	20"	17"	Metal
1995	1996	EAGLE	SUMMIT SEDAN	20"	19"	Metal
1992	1995	EAGLE	SUMMIT WAGON	22"	18"	Metal
1990	1991	EAGLE	TALON	19"	19"	Metal
1992	1994	EAGLE	TALON	20"	20"	Metal
1995	1998	EAGLE	TALON	24"	22"	Metal
1993	1994	EAGLE	VISION	24"	22"	Metal
1995	1996	EAGLE	VISION	24"	24"	Metal
1997	1998	EAGLE	VISION	24"	22"	Metal
2011	2012	FIAT	500	24"	14"	Beam
1986	1997	FORD	AEROSTAR	22"	22"	Metal
1994	1997	FORD	ASPIRE	20"	16"	Metal
1980	1996	FORD	BRONCO, BRONCO II	18"	18"	Metal
1992	1997	FORD	CLUB WAGON	22"	22"	Metal
1998	2002	FORD	CLUB WAGON	20"	20"	Metal
2012	2012	FORD	C-MAX	28"	24"	Beam
1996	2000	FORD	CONTOUR	22"	20"	Metal
1984	1991	FORD	CROWN VICTORIA	18"	18"	Metal
1992	2002	FORD	CROWN VICTORIA	22"	22"	Metal
2003	2011	FORD	CROWN VICTORIA	22"	22"	Metal
1981	1991	FORD	E-SERIES VAN	18"	18"	Metal
1992	1997	FORD	E-SERIES VAN	22"	22"	Metal
1998	2013	FORD	E-SERIES VAN	20"	20"	Metal
1981	1991	FORD	ECONOLINE	18"	18"	Metal
1992	2002	FORD	ECONOLINE	22"	22"	Metal
2007	2013	FORD	EDGE	26"	20"	Metal
2001	2003	FORD	ESCAPE	19"	18"	Metal
2004	2007	FORD	ESCAPE	20"	18"	Metal

AUTOMOTIVE APPLICATION GUIDE

START	END	MAKE	MODEL	DS	PS	TYPE
2008	2013	FORD	ESCAPE	20"	20"	Beam
1981	1990	FORD	ESCORT	18"	18"	Metal
1991	1993	FORD	ESCORT	20"	18"	Metal
1994	2000	FORD	ESCORT	20"	18"	Metal
2000	2005	FORD	EXCURSION	20"	20"	Metal
1982	1988	FORD	EXP	18"	18"	Metal
1997	2013	FORD	EXPEDITION	20"	20"	Metal
1991	2001	FORD	EXPLORER	18"	18"	Metal
2002	2004	FORD	EXPLORER	22"	22"	Metal
2005	2010	FORD	EXPLORER	20"	20"	Metal
2011	2013	FORD	EXPLORER	26"	22"	Beam
1999	2005	FORD	EXPLORER SPORT-TRAC	18"	18"	Metal
2006	2008	FORD	EXPLORER SPORT-TRAC	20"	20"	Metal
2001	2010	FORD	F-SERIES - SUPER DUTY	20"	20"	Metal
2011	2012	FORD	F-SERIES - SUPER DUTY	22"	22"	Beam
1980	1996	FORD	F-SERIES PICKUP	18"	18"	Metal
1997	1998	FORD	F-SERIES PICKUP	22"	22"	Metal
1999	2008	FORD	F-SERIES PICKUP	20"	20"	Metal
2009	-	FORD	F-SERIES PICKUP	22"	22"	Metal
-	-	FORD	F-SERIES PICKUP (ALL)	22"	22"	Beam
1987	1988	FORD	FESTIVA	17"	17"	Metal
1989	1993	FORD	FESTIVA	18"	18"	Metal
2011	2012	FORD	FIESTA	24"	16"	Beam
2005	2007	FORD	FIVE HUNDRED	24"	20"	Beam
2009	2012	FORD	FLEX	24"	22"	Metal
2000	2011	FORD	FOCUS	22"	19"	Metal
2012	2012	FORD	FOCUS	29"	29"	Beam
2004	2007	FORD	FREESTAR	24"	20"	Metal
2005	2007	FORD	FREESTYLE	24"	20"	Beam
2006	2012	FORD	FUSION	24"	19"	Metal
2005	2006	FORD	GT	24"	24"	Metal
1971	1987	FORD	LTD	18"	18"	Metal
1981	1993	FORD	MUSTANG	16"	16"	Metal
1994	2004	FORD	MUSTANG	20"	20"	Metal
2005	2009	FORD	MUSTANG	22"	20"	Metal
2010	2013	FORD	MUSTANG	22"	20"	Beam
1989	1992	FORD	PROBE	19"	17"	Metal
1993	1996	FORD	PROBE	20"	19"	Metal
1997	1997	FORD	PROBE	20"	20"	Metal
1983	1992	FORD	RANGER	18"	18"	Metal
1993	2013	FORD	RANGER	18"	18"	Metal

AUTOMOTIVE APPLICATION GUIDE



START	END	MAKE	MODEL	DS	PS	TYPE
1986	1995	FORD	TAURUS	20"	20"	Metal
1996	2006	FORD	TAURUS	24"	20"	Metal
2008	2009	FORD	TAURUS	24"	20"	Beam
2010	2013	FORD	TAURUS	26"	20"	Beam
2008	2009	FORD	TAURUS X	24"	20"	Beam
1986	1994	FORD	TEMPO	20"	20"	Metal
1983	1988	FORD	THUNDERBIRD	18"	18"	Metal
1989	1989	FORD	THUNDERBIRD	24"	20"	Metal
1990	2001	FORD	THUNDERBIRD	22"	22"	Metal
2002	2005	FORD	THUNDERBIRD	24"	22"	Metal
2010	2013	FORD	TRANSIT CONNECT	26"	18"	Metal
1998	1998	FORD	UNIVERSAL (VAN)	20"	20"	Metal
1995	2003	FORD	WINDSTAR	24"	20"	Metal
2007	2012	GMC	ACADIA	24"	21"	Beam
1973	1987	GMC	C/K-SERIES PICKUP	16"	16"	Metal
1988	2000	GMC	C/K-SERIES PICKUP	18"	18"	Metal
1978	1988	GMC	CABALLERO	18"	18"	Metal
2004	2012	GMC	CANYON	22"	19"	Metal
1991	1991	GMC	CYCLONE	16"	16"	Metal
2002	2006	GMC	ENVOY	22"	22"	Metal
2007	2009	GMC	ENVOY	22"	22"	Metal
2004	2006	GMC	ENVOY XUV	22"	22"	Metal
1964	1989	GMC	G-SERIES VAN	16"	16"	Metal
1990	1995	GMC	G-SERIES VAN	18"	18"	Metal
1973	1991	GMC	JIMMY	16"	16"	Metal
1992	1994	GMC	JIMMY	18"	18"	Metal
1995	2001	GMC	JIMMY	20"	20"	Metal
1982	1994	GMC	JIMMY (S-15 TYPE)	16"	16"	Metal
1982	1993	GMC	S/T-SERIES PICKUP	16"	16"	Metal
1994	1994	GMC	S/T-SERIES PICKUP	20"	20"	Metal
1985	2005	GMC	SAFARI	18"	18"	Metal
1997	2012	GMC	SAVANA	22"	22"	Metal
1991	1998	GMC	SIERRA	18"	18"	Metal
1999	2006	GMC	SIERRA	22"	22"	Metal
2007	2013	GMC	SIERRA	22"	22"	Beam
2007	2007	GMC	SIERRA CLASSIC	22"	22"	Metal
1994	2004	GMC	SONOMA	20"	20"	Metal
1973	1991	GMC	SUBURBAN	16"	16"	Metal
1992	1999	GMC	SUBURBAN	18"	18"	Metal
2010	2012	GMC	TERRAIN	24"	17"	Beam
1992	1993	GMC	TYPHOON	16"	16"	Metal

AUTOMOTIVE APPLICATION GUIDE

START	END	MAKE	MODEL	DS	PS	TYPE
1996	2002	GMC	VAN	22"	22"	Metal
1988	1990	GMC	VANDURA	16"	16"	Metal
1992	1999	GMC	YUKON (ALL)	18"	18"	Metal
2000	2006	GMC	YUKON (ALL)	22"	22"	Metal
2007	2008	GMC	YUKON (ALL)	22"	22"	Beam
2009	2013	GMC	YUKON (ALL)	22"	22"	Metal
1989	1992	GEO	METRO	18"	18"	Metal
1993	1997	GEO	METRO	20"	18"	Metal
1989	1992	GEO	PRIZM	19"	17"	Metal
1993	1997	GEO	PRIZM	20"	18"	Metal
1989	1989	GEO	SPECTRUM	18"	18"	Metal
1989	1989	GEO	SPRINT	17"	17"	Metal
1990	1993	GEO	STORM	22"	22"	Metal
1990	1993	GEO	STORM HATCHBACK	22"	22"	Metal
1989	1990	GEO	TRACKER	17"	17"	Metal
1991	1997	GEO	TRACKER	17"	17"	Metal
1986	1989	HONDA	ACCORD	19"	19"	Metal
1990	2002	HONDA	ACCORD	24"	19"	Metal
2003	2007	HONDA	ACCORD	26"	18"	Metal
2008	2013	HONDA	ACCORD (INC. CROSSTOUR)	26"	19"	Beam
1987	1991	HONDA	CIVIC	20"	19"	Metal
1992	1995	HONDA	CIVIC	22"	18"	Metal
1996	2000	HONDA	CIVIC	20"	18"	Metal
2001	2005	HONDA	CIVIC	21"	19"	Metal
2006	2011	HONDA	CIVIC COUPE	28"	24"	Beam
2012	2013	HONDA	CIVIC COUPE	28"	24"	Beam
1986	1990	HONDA	CIVIC CRX	20"	20"	Metal
1994	1998	HONDA	CIVIC DEL SOL	22"	19"	Metal
2006	2013	HONDA	CIVIC SEDAN	26"	22"	Beam
2004	2005	HONDA	CIVIC SI	24"	19"	Metal
1997	2001	HONDA	CR-V	20"	19"	Metal
2002	2006	HONDA	CR-V	21"	20"	Metal
2007	2011	HONDA	CR-V	26"	17"	Beam
2012	2013	HONDA	CR-V	26"	16"	Beam
2011	2013	HONDA	CR-Z	26"	21"	Beam
2003	2012	HONDA	ELEMENT	20"	20"	Metal
2003	2003	HONDA	FCX	24"	22"	Metal
2007	2008	HONDA	FIT	24"	16"	Beam
2009	2012	HONDA	FIT	28"	14"	Beam
2000	2006	HONDA	INSIGHT	22"	19"	Metal
2010	2012	HONDA	INSIGHT	26"	18"	Beam

AUTOMOTIVE APPLICATION GUIDE



START	END	MAKE	MODEL	DS	PS	TYPE
1995	1998	HONDA	ODYSSEY	24"	24"	Metal
1999	2004	HONDA	ODYSSEY	24"	21"	Metal
2005	2007	HONDA	ODYSSEY	26"	22"	Metal
2008	2010	HONDA	ODYSSEY	26"	22"	Beam
2011	2013	HONDA	ODYSSEY	26"	22"	Metal
1994	1997	HONDA	PASSPORT	18"	18"	Metal
1998	2002	HONDA	PASSPORT	19"	19"	Metal
2003	2008	HONDA	PILOT	24"	21"	Metal
2009	2013	HONDA	PILOT	22"	21"	Metal
1983	1987	HONDA	PRELUDE	19"	19"	Metal
1988	1990	HONDA	PRELUDE	20"	19"	Metal
1991	1996	HONDA	PRELUDE	22"	19"	Metal
1997	2002	HONDA	PRELUDE	21"	19"	Metal
2006	2012	HONDA	RIDGELINE	24"	22"	Metal
2000	2009	HONDA	S2000	16"	20"	Metal
1995	2006	HUMMER	H1	11"	11"	Metal
2003	2010	HUMMER	H2	17"	17"	Metal
2006	2010	HUMMER	H3	17"	17"	Metal
1995	2011	HYUNDAI	ACCENT	22"	16"	Metal
2012	2013	HYUNDAI	ACCENT	26"	16"	Metal
2006	2011	HYUNDAI	AZERA	24"	20"	Metal
2012	2013	HYUNDAI	AZERA	26"	18"	Beam
1992	2006	HYUNDAI	ELANTRA	20"	18"	Metal
2007	2010	HYUNDAI	ELANTRA	24"	18"	Metal
2011	2013	HYUNDAI	ELANTRA	28"	14"	Metal
2009	2012	HYUNDAI	ELANTRA TOURING	24"	18"	Metal
2007	2010	HYUNDAI	ENTOURAGE	26"	18"	Metal
2011	2012	HYUNDAI	EQUUS	24"	20"	Beam
1986	1989	HYUNDAI	EXCEL	17"	17"	Metal
1990	1994	HYUNDAI	EXCEL	18"	18"	Metal
2009	2012	HYUNDAI	GENESIS COUPE	24"	20"	Metal
2009	2011	HYUNDAI	GENESIS SEDAN	24"	20"	Beam
2012	2013	HYUNDAI	GENESIS SEDAN	24"	20"	Beam
1984	1988	HYUNDAI	PONY	17"	17"	Metal
2001	2006	HYUNDAI	SANTA FE	22"	20"	Metal
2007	2012	HYUNDAI	SANTA FE	24"	18"	Metal
1991	1995	HYUNDAI	SCOUPE	19"	18"	Metal
1990	1993	HYUNDAI	SONATA	20"	18"	Metal
1994	2005	HYUNDAI	SONATA	20"	20"	Metal
2006	2010	HYUNDAI	SONATA	24"	19"	Metal
2011	2012	HYUNDAI	SONATA	26"	18"	Beam

AUTOMOTIVE APPLICATION GUIDE

START	END	MAKE	MODEL	DS	PS	TYPE
1985	1988	HYUNDAI	STELLAR	18"	18"	Metal
1997	2008	HYUNDAI	TIBURON	22"	18"	Metal
2005	2013	HYUNDAI	TUCSON	24"	16"	Metal
2012	2012	HYUNDAI	VELOSTER	26"	18"	Metal
2007	2012	HYUNDAI	VERACRUZ	24"	20"	Beam
2001	2002	HYUNDAI	XG300	22"	19"	Metal
2002	2005	HYUNDAI	XG350	22"	20"	Metal
2008	2012	INFINITI	EX35	22"	18"	Beam
2004	2008	INFINITI	FX35/FX45	22"	20"	Metal
2009	2012	INFINITI	FX35/FX45	22"	19"	Beam
1991	2001	INFINITI	G20	21"	19"	Metal
2003	2006	INFINITI	G35	24"	17"	Metal
2007	2007	INFINITI	G35 COUPE	24"	17"	Metal
2008	2012	INFINITI	G-SERIES COUPE	26"	16"	Beam
2007	2012	INFINITI	G-SERIES SEDAN	26"	16"	Beam
1997	1999	INFINITI	I30	22"	21"	Metal
2000	2002	INFINITI	I30	26"	17"	Metal
2002	2004	INFINITI	I35	26"	17"	Metal
2013	2013	INFINITI	JX	26"	17"	Beam
1990	1992	INFINITI	M30	21"	19"	Metal
2003	2003	INFINITI	M45	21"	19"	Metal
2006	2010	INFINITI	M-SERIES	24"	19"	Metal
2011	2012	INFINITI	M-SERIES	26"	19"	Beam
1990	1996	INFINITI	Q45	21"	21"	Metal
1997	2001	INFINITI	Q45	22"	20"	Metal
2002	2007	INFINITI	Q45	26"	18"	Metal
1997	2003	INFINITI	QX4	22"	21"	Metal
2004	2010	INFINITI	QX56	24"	22"	Metal
2011	2012	INFINITI	QX56	24"	19"	Beam
1989	1997	ISUZU	AMIGO	18"	18"	Metal
1998	2001	ISUZU	AMIGO	19"	19"	Metal
2003	2006	ISUZU	ASCENDER	22"	22"	Metal
2007	2008	ISUZU	ASCENDER	22"	22"	Metal
2002	2004	ISUZU	AXIOM	20"	19"	Metal
1997	2001	ISUZU	HOMBRE	20"	20"	Metal
1982	1989	ISUZU	i-MARK	18"	18"	Metal
2006	2008	ISUZU	i-SERIES	22"	19"	Metal
1990	1992	ISUZU	IMPULSE	22"	22"	Metal
1990	1992	ISUZU	IMPULSE REAR SQUAREBACK	22"	22"	Metal
1985	1994	ISUZU	NPR	19"	19"	Metal
1996	1999	ISUZU	OASIS	24"	24"	Metal

AUTOMOTIVE APPLICATION GUIDE



START	END	MAKE	MODEL	DS	PS	TYPE
1988	1990	ISUZU	OPTIMA	18"	18"	Metal
1981	1988	ISUZU	PICKUP	17"	17"	Metal
1989	1995	ISUZU	PICKUP	18"	18"	Metal
1991	1997	ISUZU	RODEO	18"	18"	Metal
1998	2004	ISUZU	RODEO/RODEO SPORT	19"	19"	Metal
1991	1993	ISUZU	STYLUS	22"	20"	Metal
1984	1991	ISUZU	TROOPER	17"	17"	Metal
1992	2002	ISUZU	TROOPER	20"	20"	Metal
1999	2001	ISUZU	VEHI-CROSS	24"	17"	Metal
2000	2008	JAGUAR	S-TYPE	22"	22"	Metal
2005	2008	JAGUAR	SUPER V8	24"	19"	Metal
1993	2003	JAGUAR	VADEN PLAS	21"	21"	Metal
2004	2008	JAGUAR	VADEN PLAS	24"	19"	Metal
2009	2012	JAGUAR	XF	24"	19"	Beam
2004	2010	JAGUAR	XJ	21"	21"	Metal
2011	2012	JAGUAR	XJ	22"	19"	Beam
1994	2005	JAGUAR	XJ12	21"	-	Metal
1972	1987	JAGUAR	XJ6	15"	15"	Metal
1988	1997	JAGUAR	XJ6	21"	21"	Metal
1998	2003	JAGUAR	XJ8	21"	21"	Metal
1995	2003	JAGUAR	XJR	21"	21"	Metal
2004	2009	JAGUAR	XJR	24"	19"	Metal
1976	1995	JAGUAR	XJS	15"	15"	Metal
1997	2006	JAGUAR	XK	21"	21"	Metal
2007	2012	JAGUAR	XK	22"	21"	Beam
2000	2009	JAGUAR	XKR	21"	21"	Metal
2010	2012	JAGUAR	XKR	22"	21"	Metal
2002	2008	JAGUAR	X-TYPE	22"	19"	Metal
2007	2007	JAGUAR	XK-TYPE	22"	21"	Metal
1984	2001	JEEP	CHEROKEE	18"	18"	Metal
2006	2010	JEEP	COMMANDER	18"	18"	Metal
2007	2012	JEEP	COMPASS	22"	20"	Metal
1992	1998	JEEP	GRAND CHEROKEE	20"	20"	Metal
1999	2004	JEEP	GRAND CHEROKEE	21"	21"	Metal
2005	2010	JEEP	GRAND CHEROKEE	21"	21"	Metal
2011	2012	JEEP	GRAND CHEROKEE	22"	21"	Metal
1978	1991	JEEP	GRAND WAGONEER	16"	16"	Metal
2002	2007	JEEP	LIBERTY	19"	19"	Metal
2008	2012	JEEP	LIBERTY	19"	19"	Metal
2007	2010	JEEP	PATRIOT	22"	20"	Metal
2011	2012	JEEP	PATRIOT	21"	21"	Metal

AUTOMOTIVE APPLICATION GUIDE

START	END	MAKE	MODEL	DS	PS	TYPE
1978	1987	JEEP	TRUCK	16"	16"	Metal
1984	1990	JEEP	WAGONEER	18"	18"	Metal
1987	1995	JEEP	WRANGLER	11"	11"	Metal
1996	2006	JEEP	WRANGLER	13"	13"	Metal
2007	2013	JEEP	WRANGLER	15"	15"	Metal
2004	2009	KIA	AMANTI	24"	18"	Metal
2009	2011	KIA	BORREGO	24"	20"	Beam
1996	1996	KIA	CREDOS	21"	19"	Metal
2010	2012	KIA	FORTE	24"	20"	Metal
2001	2006	KIA	OPTIMA	22"	20"	Metal
2007	2012	KIA	OPTIMA	24"	18"	Metal
2001	2005	KIA	RIO	21"	17"	Metal
2006	2011	KIA	RIO	22"	16"	Metal
2012	2012	KIA	RIO	26"	16"	Metal
2007	2011	KIA	RONDO	26"	16"	Metal
2002	2005	KIA	SEDONA	24"	24"	Metal
2006	2012	KIA	SEDONA	26"	18"	Metal
1994	2001	KIA	SEPHIA	21"	19"	Metal
2003	2009	KIA	SORENTO	24"	18"	Metal
2010	2013	KIA	SORENTO	24"	20"	Metal
2010	2012	KIA	SOUL	24"	20"	Metal
2000	2003	KIA	SPECTRA	21"	19"	Metal
2004	2009	KIA	SPECTRA	24"	16"	Metal
1995	2002	KIA	SPORTAGE	20"	20"	Metal
2005	2010	KIA	SPORTAGE	24"	16"	Metal
2011	2013	KIA	SPORTAGE	24"	18"	Metal
1994	1997	LAND ROVER	DEFENDER, 90	13"	13"	Metal
1994	1999	LAND ROVER	DISCOVERY	18"	18"	Metal
2000	2004	LAND ROVER	DISCOVERY	21"	21"	Metal
2012	2012	LAND ROVER	EVOQUE	22"	22"	Beam
2003	2005	LAND ROVER	FREELANDER	22"	21"	Metal
2007	2012	LAND ROVER	LR2	24"	20"	Beam
2005	2009	LAND ROVER	LR3	22"	22"	Beam
2010	2012	LAND ROVER	LR4	22"	22"	Beam
1978	1989	LAND ROVER	RANGE ROVER	17"	17"	Metal
1990	1994	LAND ROVER	RANGE ROVER	18"	18"	Metal
1995	2001	LAND ROVER	RANGE ROVER	22"	22"	Metal
2006	2012	LAND ROVER	RANGE ROVER SPORT	22"	22"	Beam
2011	2012	LEXUS	CT 200h	26"	18"	Beam
1990	1991	LEXUS	ES	19"	17"	Metal
1992	1996	LEXUS	ES	21"	19"	Metal

AUTOMOTIVE APPLICATION GUIDE



START	END	MAKE	MODEL	DS	PS	TYPE
1997	2003	LEXUS	ES	22"	18"	Metal
2004	2006	LEXUS	ES	24"	20"	Metal
2007	2012	LEXUS	ES	24"	18"	Beam
1993	1997	LEXUS	GS	21"	19"	Metal
1998	2005	LEXUS	GS	24"	20"	Metal
2006	2012	LEXUS	GS	24"	19"	Beam
2013	2013	LEXUS	GS	26"	18"	Beam
2003	2009	LEXUS	GX	22"	21"	Metal
2010	2012	LEXUS	GX460	26"	20"	Beam
2010	2012	LEXUS	HS 250h	26"	18"	Beam
2001	2005	LEXUS	IS	22"	20"	Metal
2006	2012	LEXUS	IS	22"	20"	Beam
1990	2000	LEXUS	LS	22"	16"	Metal
2001	2006	LEXUS	LS	24"	16"	Metal
2007	2012	LEXUS	LS	24"	17"	Beam
1996	1997	LEXUS	LX	18"	16"	Metal
1998	1999	LEXUS	LX	20"	16"	Metal
2000	2007	LEXUS	LX	24"	22"	Metal
2008	2013	LEXUS	LX	24"	22"	Beam
1999	2003	LEXUS	RX	24"	21"	Metal
2004	2009	LEXUS	RX	26"	22"	Metal
2010	2013	LEXUS	RX	26"	22"	Beam
1992	2001	LEXUS	SC	21"	20"	Metal
2002	2008	LEXUS	SC	24"	20"	Metal
2003	2005	LINCOLN	AVIATOR	22"	22"	Metal
2002	2003	LINCOLN	BLACKWOOD	22"	22"	Metal
1982	1997	LINCOLN	CONTINENTAL	20"	20"	Metal
1992	2002	LINCOLN	CONTINENTAL	20"	20"	Metal
2000	2006	LINCOLN	LS	24"	19"	Metal
2006	2008	LINCOLN	MARK LT	20"	20"	Metal
1972	1992	LINCOLN	MARK-SERIES	18"	18"	Metal
1993	1998	LINCOLN	MARK VIII	22"	22"	Metal
2009	2012	LINCOLN	MKS	26"	20"	Beam
2010	2012	LINCOLN	MKT	24"	22"	Beam
2007	2010	LINCOLN	MKX	26"	20"	Metal
2006	2012	LINCOLN	MKZ	24"	19"	Metal
1997	2013	LINCOLN	NAVIGATOR	20"	20"	Metal
1981	1989	LINCOLN	TOWN CAR	18"	18"	Metal
1990	1992	LINCOLN	TOWN CAR	22"	22"	Metal
1993	2011	LINCOLN	TOWN CAR, LIMO	22"	22"	Metal
2006	2006	LINCOLN	ZEPHYR	24"	19"	Metal

AUTOMOTIVE APPLICATION GUIDE

START	END	MAKE	MODEL	DS	PS	TYPE
2006	2013	MAZDA	5	26"	16"	Metal
2011	2013	MAZDA	2	24"	14"	Metal
2004	2009	MAZDA	3	22"	18"	Metal
2010	2013	MAZDA	3	24"	19"	Metal
1986	1989	MAZDA	323	18"	18"	Metal
1990	1995	MAZDA	323	21"	18"	Metal
2003	2008	MAZDA	6	22"	18"	Metal
2009	2013	MAZDA	6	24"	18"	Beam
1986	1987	MAZDA	626	18"	18"	Metal
1988	1992	MAZDA	626	19"	19"	Metal
1993	1997	MAZDA	626	21"	20"	Metal
1998	2002	MAZDA	626	20"	19"	Metal
1988	1991	MAZDA	929	20"	19"	Metal
1992	1996	MAZDA	929	21"	20"	Metal
2013	2013	MAZDA	CX-5	24"	18"	Beam
2007	2012	MAZDA	CX-7	26"	16"	Beam
2007	2012	MAZDA	CX-9	26"	16"	Beam
1989	1999	MAZDA	MPV	22"	20"	Metal
2000	2006	MAZDA	MPV	24"	24"	Metal
1995	2000	MAZDA	MILLENIA	21"	20"	Metal
1992	1996	MAZDA	MX-3	21"	18"	Metal
1990	2012	MAZDA	MX-5 (MIATA)	18"	18"	Metal
1988	1992	MAZDA	MX-6	19"	19"	Metal
1993	1997	MAZDA	MX-6	20"	20"	Metal
1991	1994	MAZDA	NAVAJO	18"	18"	Metal
1987	2011	MAZDA	PICKUP, B-SERIES	18"	18"	Metal
1990	2003	MAZDA	PROTEGE	21"	18"	Metal
1998	1998	MAZDA	RX-300	24"	21"	Metal
1986	1996	MAZDA	RX-7	20"	20"	Metal
2004	2011	MAZDA	RX-8	20"	18"	Metal
2003	2003	MAZDA	SERIES 6	22"	18"	Metal
2001	2007	MAZDA	TRIBUTE	20"	18"	Metal
2008	2011	MAZDA	TRIBUTE	20"	20"	Beam
1985	1993	MERCEDES-BENZ	190	24"	-	Metal
1987	1989	MERCEDES-BENZ	260E	24"	-	Metal
1977	1985	MERCEDES-BENZ	300E, D, CD, CE, TD, TE	20"	20"	Metal
1986	1987	MERCEDES-BENZ	300E, D, CD, CE, TD, TE	24"	-	Metal
1988	1993	MERCEDES-BENZ	300E, D, CD, CE, TD, TE	24"	-	Metal
1990	1993	MERCEDES-BENZ	300SL	24"	-	Metal
1981	1985	MERCEDES-BENZ	380SL, SLC	19"	19"	Metal
1991	1993	MERCEDES-BENZ	400E	24"	-	Metal

AUTOMOTIVE APPLICATION GUIDE

00

AUTOMOTIVE APPLICATION GUIDE

START	END	MAKE	MODEL	DS	PS	TYPE
1992	1993	MERCEDES-BENZ	500E	24"	-	Metal
1990	1993	MERCEDES-BENZ	500SL	24"	-	Metal
1986	1989	MERCEDES-BENZ	560SL	18"	18"	Metal
1993	1993	MERCEDES-BENZ	600SL	24"	-	Metal
2009	2012	MERCEDES-BENZ	C-CLASS MODEL W204	24"	24"	Beam
1994	2000	MERCEDES-BENZ	C-CLASS MODEL W202	24"	-	Metal
2001	2003	MERCEDES-BENZ	C-CLASS MODEL W203	24"	22"	Metal
2004	2008	MERCEDES-BENZ	C-CLASS MODEL W203	22"	22"	Beam
2000	2012	MERCEDES-BENZ	CL-CLASS MODEL C215 & C216	26"	26"	Beam
1998	2002	MERCEDES-BENZ	CLK-CLASS MODEL C208 & A208	24"	-	Metal
2003	2009	MERCEDES-BENZ	CLK-CLASS MODEL C209 & A209	22"	22"	Beam
2012	2012	MERCEDES-BENZ	CLS-CLASS MODEL W218	24"	24"	Beam
2006	2011	MERCEDES-BENZ	CLS-CLASS MODEL W219	26"	26"	Beam
1985	2002	MERCEDES-BENZ	E-CLASS MODEL W124 & W210	24"	-	Metal
2003	2008	MERCEDES-BENZ	E-CLASS MODEL W211	26"	26"	Beam
2009	2012	MERCEDES-BENZ	E-CLASS MODEL W212	26"	26"	Beam
1977	1984	MERCEDES-BENZ	E-CLASS MODEL W123	20"	20"	Metal
1990	2011	MERCEDES-BENZ	G-CLASS MODEL 463	16"	16"	Metal
2007	2012	MERCEDES-BENZ	GL-CLASS MODEL X164	26"	21"	Beam
2010	2012	MERCEDES-BENZ	GLK-CLASS MODEL X204	22"	19"	Beam
1998	2005	MERCEDES-BENZ	M-CLASS MODEL W163	22"	22"	Metal
2006	2011	MERCEDES-BENZ	M-CLASS MODEL W164	26"	21"	Beam
-	-	MERCEDES-BENZ	M-CLASS MODEL W164	28"	21"	Beam
-	-	MERCEDES-BENZ	M-CLASS MODEL W166	26"	22"	Beam
2006	2012	MERCEDES-BENZ	R-CLASS MODEL V251	26"	21"	Beam
2000	2006	MERCEDES-BENZ	S-CLASS MODEL W220	26"	26"	Beam
2007	2012	MERCEDES-BENZ	S-CLASS MODEL W221	27"	27"	Beam
2002	2012	MERCEDES-BENZ	SL-CLASS MODEL R230	26"	26"	Beam
1972	1989	MERCEDES-BENZ	SL-CLASS MODEL R107	18"	18"	Metal
1990	2001	MERCEDES-BENZ	SL-CLASS MODEL R129	24"	-	Metal
1996	2004	MERCEDES-BENZ	SLK-CLASS MODEL R170	22"	-	Metal
2005	2011	MERCEDES-BENZ	SLK-CLASS MODEL R171	26"	26"	Beam
2012	2012	MERCEDES-BENZ	SLK-CLASS MODEL R172	22"	22"	Beam
2005	2009	MERCEDES-BENZ	SLR-CLASS	26"	26"	Beam
2008	2012	MERCEDES-BENZ	SPRINTER TRUCK	26"	24"	Beam
1979	1980	MERCURY	CAPRI	17"	17"	Metal
1981	1987	MERCURY	CAPRI	16"	16"	Metal
1988	1994	MERCURY	CAPRI	20"	18"	Metal
1974	1982	MERCURY	COUGAR	16"	16"	Metal
1983	1988	MERCURY	COUGAR	18"	18"	Metal
1989	1989	MERCURY	COUGAR	24"	20"	Metal

AUTOMOTIVE APPLICATION GUIDE

START	END	MAKE	MODEL	DS	PS	TYPE
1990	1997	MERCURY	COUGAR	22"	22"	Metal
1998	2002	MERCURY	COUGAR	22"	19"	Metal
1971	1991	MERCURY	GRAND MARQUIS	18"	18"	Metal
1992	2010	MERCURY	GRAND MARQUIS	22"	22"	Metal
1982	1984	MERCURY	LN7	18"	18"	Metal
1981	1987	MERCURY	LYNX	18"	18"	Metal
1981	1987	MERCURY	LYNX WAGON	18"	18"	Metal
2004	2004	MERCURY	MARAUDER	22"	22"	Metal
2005	2007	MERCURY	MARINER	20"	18"	Metal
2008	2011	MERCURY	MARINER	20"	20"	Beam
1971	1986	MERCURY	MARQUIS	18"	18"	Metal
1985	1989	MERCURY	MERKUR SCORPIO	20"	20"	Metal
1985	1989	MERCURY	MERKUR XR4Ti	20"	20"	Metal
2006	2011	MERCURY	MILAN	24"	19"	Metal
1975	1980	MERCURY	MONARCH	16"	16"	Metal
2005	2008	MERCURY	MONTEGO	24"	20"	Beam
2004	2006	MERCURY	MONTEREY	24"	20"	Metal
1997	2001	MERCURY	MOUNTAINEER	18"	18"	Metal
2002	2004	MERCURY	MOUNTAINEER	22"	22"	Metal
2005	2010	MERCURY	MOUNTAINEER	20"	20"	Metal
1995	2000	MERCURY	MYSTIQUE	22"	20"	Metal
1986	1995	MERCURY	SABLE	20"	20"	Metal
1996	2005	MERCURY	SABLE	24"	20"	Metal
2006	2009	MERCURY	SABLE	24"	20"	Beam
1984	1985	MERCURY	TOPAZ	19"	19"	Metal
1986	1995	MERCURY	TOPAZ	20"	20"	Metal
1987	1989	MERCURY	TRACER	18"	18"	Metal
1990	1993	MERCURY	TRACER	20"	-	Metal
1994	1999	MERCURY	TRACER	20"	18"	Metal
1998	1998	MERCURY	TRIO	20"	18"	Metal
1993	2002	MERCURY	VILLAGER	22"	22"	Metal
1978	1983	MERCURY	ZEPHYR	16"	16"	Metal
2002	2012	MINI	COOPER/CLUBMAN	18"	19"	Metal
2011	2012	MINI	COUNTRYMAN	19"	20"	Beam
2012	2012	MINI	COUPE	20"	21"	Beam
1991	1999	MITSUBISHI	3000 GT	21"	20"	Metal
1983	1988	MITSUBISHI	CORDIA	19"	19"	Metal
1992	1996	MITSUBISHI	DIAMANTE	20"	19"	Metal
1997	2004	MITSUBISHI	DIAMANTE	22"	20"	Metal
1992	1994	MITSUBISHI	ECLIPSE	20"	20"	Metal
1995	2013	MITSUBISHI	ECLIPSE	24"	22"	Metal

AUTOMOTIVE APPLICATION GUIDE

START	END	MAKE	MODEL	DS	PS	TYPE
1990	1991	MITSUBISHI	ECLIPSE	19"	19"	Metal
2004	2011	MITSUBISHI	ENDEAVOR	26"	21"	Metal
1992	1994	MITSUBISHI	EXPO, LRV	22"	18"	Metal
1989	1995	MITSUBISHI	FUSO (TILT CAB)	19"	19"	Metal
1985	1988	MITSUBISHI	GALANT	17"	17"	Metal
1989	1993	MITSUBISHI	GALANT	19"	17"	Metal
1994	1998	MITSUBISHI	GALANT	21"	19"	Metal
1999	2003	MITSUBISHI	GALANT	24"	18"	Metal
2004	2013	MITSUBISHI	GALANT	26"	19"	Metal
2002	2007	MITSUBISHI	LANCER	24"	18"	Metal
2008	2012	MITSUBISHI	LANCER	26"	18"	Metal
1985	1990	MITSUBISHI	MIRAGE	19"	17"	Metal
1991	1992	MITSUBISHI	MIRAGE	20"	17"	Metal
1993	2002	MITSUBISHI	MIRAGE	20"	19"	Metal
1995	1996	MITSUBISHI	MONTERO	19"	19"	Metal
1997	2000	MITSUBISHI	MONTERO	19"	19"	Metal
2001	2006	MITSUBISHI	MONTERO	20"	20"	Metal
1997	2004	MITSUBISHI	MONTERO SPORT	20"	20"	Metal
2003	2006	MITSUBISHI	OUTLANDER	22"	19"	Metal
2007	2009	MITSUBISHI	OUTLANDER	24"	21"	Metal
2010	2012	MITSUBISHI	OUTLANDER	24"	21"	Beam
2010	2012	MITSUBISHI	OUTLANDER SPORT	24"	21"	Beam
1983	1986	MITSUBISHI	PICKUP TRUCK	16"	16"	Metal
1987	1994	MITSUBISHI	PICKUP TRUCK	17"	17"	Metal
1987	1992	MITSUBISHI	PRECIS	18"	18"	Metal
2006	2009	MITSUBISHI	RAIDER	21"	21"	Metal
1983	1989	MITSUBISHI	STARION	19"	19"	Metal
1983	1987	MITSUBISHI	TREDIA	17"	17"	Metal
1987	1990	MITSUBISHI	VAN	17"	17"	Metal
1979	1982	NISSAN	310	17"	17"	Metal
1978	1981	NISSAN	510	17"	17"	Metal
1981	1981	NISSAN	810	18"	18"	Metal
1980	1986	NISSAN	200SX	19"	19"	Metal
1987	1988	NISSAN	200SX	21"	21"	Metal
1995	1998	NISSAN	200SX, SE, SER	21"	19"	Metal
1989	1994	NISSAN	240SX	20"	20"	Metal
1995	1998	NISSAN	240SX	21"	20"	Metal
1975	1983	NISSAN	280Z, 280ZX	17"	17"	Metal
1984	1989	NISSAN	300ZX	19"	19"	Metal
1990	1996	NISSAN	300ZX	21"	21"	Metal
2003	2009	NISSAN	350Z	20"	18"	Metal

AUTOMOTIVE APPLICATION GUIDE

START	END	MAKE	MODEL	DS	PS	TYPE
2009	2012	NISSAN	370Z	21"	19"	Metal
1993	2001	NISSAN	ALTIMA	21"	20"	Metal
2002	2006	NISSAN	ALTIMA	26"	17"	Metal
2007	2012	NISSAN	ALTIMA	28"	16"	Beam
2004	2012	NISSAN	ARMADA	26"	22"	Metal
1990	1990	NISSAN	AXXESS	28"	22"	Metal
2010	2012	NISSAN	CUBE	20"	20"	Metal
1998	2004	NISSAN	FRONTIER	19"	19"	Metal
2005	2012	NISSAN	FRONTIER	24"	18"	Metal
2010	2012	NISSAN	GT-R	22"	19"	Beam
2011	2012	NISSAN	JUKE	23"	14"	Metal
2011	2012	NISSAN	LEAF	26"	16"	Beam
1981	1984	NISSAN	MAXIMA	18"	18"	Metal
1985	1988	NISSAN	MAXIMA	19"	19"	Metal
1989	1994	NISSAN	MAXIMA	21"	20"	Metal
1995	1999	NISSAN	MAXIMA	22"	21"	Metal
2000	2008	NISSAN	MAXIMA	26"	17"	Metal
2009	2013	NISSAN	MAXIMA	28"	16"	Beam
1987	1991	NISSAN	MICRA	18"	18"	Metal
1986	1988	NISSAN	MULTI	19"	19"	Metal
2004	2005	NISSAN	MURANO	26"	19"	Metal
2006	2008	NISSAN	MURANO	26"	18"	Beam
2009	2013	NISSAN	MURANO	26"	16"	Beam
1992	1993	NISSAN	NX	20"	19"	Metal
2011	2012	NISSAN	NV-SERIES VAN	21"	21"	Metal
1996	2004	NISSAN	PATHFINDER	22"	21"	Metal
2005	2013	NISSAN	PATHFINDER	24"	18"	Metal
1996	2000	NISSAN	PICKUP	19"	19"	Metal
1972	1985	NISSAN	PICKUP, PATHFINDER	16"	16"	Metal
1986	1995	NISSAN	PICKUP, PATHFINDER	19"	19"	Metal
1983	1986	NISSAN	PULSAR	19"	19"	Metal
1987	1990	NISSAN	PULSAR	21"	21"	Metal
1993	2003	NISSAN	QUEST	22"	22"	Metal
2004	2009	NISSAN	QUEST	26"	18"	Metal
2010	2012	NISSAN	QUEST	26"	19"	Beam
2009	2012	NISSAN	ROGUE	26"	14"	Metal
1982	1990	NISSAN	SENTRA	18"	18"	Metal
1991	1999	NISSAN	SENTRA	21"	19"	Metal
2000	2006	NISSAN	SENTRA	22"	17"	Metal
2007	2012	NISSAN	SENTRA	26"	16"	Metal
1982	1986	NISSAN	STANZA	18"	18"	Metal

AUTOMOTIVE APPLICATION GUIDE

START	END	MAKE	MODEL	DS	PS	TYPE
1987	1989	NISSAN	STANZA	19"	19"	Metal
1990	1992	NISSAN	STANZA	20"	20"	Metal
2004	2012	NISSAN	TITAN	24"	22"	Metal
1987	1989	NISSAN	VAN	22"	19"	Metal
2007	2012	NISSAN	VERSA HATCHBACK	22"	14"	Metal
2012	2012	NISSAN	VERSA SEDAN	24"	14"	Metal
2000	2004	NISSAN	X-TERRA	19"	19"	Metal
2005	2012	NISSAN	X-TERRA	24"	18"	Metal
1991	2000	OLDSMOBILE	88	22"	22"	Metal
1963	1984	OLDSMOBILE	98	18"	18"	Metal
1985	1990	OLDSMOBILE	98	19"	19"	Metal
1991	1995	OLDSMOBILE	98	22"	22"	Metal
1992	1997	OLDSMOBILE	ACHEIVA	19"	19"	Metal
1998	2004	OLDSMOBILE	ALERO	22"	17"	Metal
1995	2003	OLDSMOBILE	AURORA	22"	22"	Metal
1991	1994	OLDSMOBILE	BRAVADA	16"	16"	Metal
1995	2001	OLDSMOBILE	BRAVADA	20"	20"	Metal
2002	2004	OLDSMOBILE	BRAVADA	22"	22"	Metal
1985	1991	OLDSMOBILE	CALAIS	19"	19"	Metal
1984	1996	OLDSMOBILE	CIERA	18"	18"	Metal
1971	1990	OLDSMOBILE	CUSTOM CRUISER	18"	18"	Metal
1991	1992	OLDSMOBILE	CUSTOM CRUISER	22"	22"	Metal
1978	1987	OLDSMOBILE	CUTLASS	18"	18"	Metal
1988	1996	OLDSMOBILE	CUTLASS	20"	20"	Metal
1997	1999	OLDSMOBILE	CUTLASS	22"	19"	Metal
1984	1995	OLDSMOBILE	CUTLASS CRUISER	18"	18"	Metal
1988	1997	OLDSMOBILE	CUTLASS SUPREME	20"	20"	Metal
1963	1985	OLDSMOBILE	DELTA 88	18"	18"	Metal
1986	1991	OLDSMOBILE	DELTA 88	19"	19"	Metal
1982	1988	OLDSMOBILE	FIRENZA	16"	16"	Metal
1997	2002	OLDSMOBILE	INTRIGUE	22"	22"	Metal
1996	2000	OLDSMOBILE	LSS	22"	22"	Metal
1980	1984	OLDSMOBILE	OMEGA	18"	18"	Metal
1997	1998	OLDSMOBILE	REGENCY	22"	22"	Metal
1990	2004	OLDSMOBILE	SILHOUETTE	24"	24"	Metal
1975	1980	OLDSMOBILE	STARFIRE	16"	16"	Metal
1968	1985	OLDSMOBILE	TORONADO	18"	18"	Metal
1986	1992	OLDSMOBILE	TORONADO	19"	19"	Metal
1990	1990	OLDSMOBILE	TROFEO	19"	19"	Metal
1964	1989	OLDSMOBILE	VISTA CRUISER	18"	18"	Metal
1989	1995	PLYMOUTH	ACCLAIM	18"	18"	Metal

AUTOMOTIVE APPLICATION GUIDE

START	END	MAKE	MODEL	DS	PS	TYPE
1979	1982	PLYMOUTH	ARROW PICKUP	17"	17"	Metal
1996	2000	PLYMOUTH	BREEZE	22"	22"	Metal
1985	1988	PLYMOUTH	CARAVELLE	16"	16"	Metal
1979	1982	PLYMOUTH	CHAMP	17"	17"	Metal
1979	1984	PLYMOUTH	COLT	17"	17"	Metal
1985	1992	PLYMOUTH	COLT	19"	17"	Metal
1993	1994	PLYMOUTH	COLT	20"	19"	Metal
1992	1994	PLYMOUTH	COLT VISTA	22"	18"	Metal
1984	1986	PLYMOUTH	CONQUEST	19"	19"	Metal
1974	1988	PLYMOUTH	FURY	18"	18"	Metal
1978	1990	PLYMOUTH	HORIZON	16"	16"	Metal
1990	1991	PLYMOUTH	LASER	19"	19"	Metal
1992	1994	PLYMOUTH	LASER	20"	20"	Metal
1994	1999	PLYMOUTH	NEON	21"	18"	Metal
2000	2000	PLYMOUTH	NEON	22"	19"	Metal
2000	2001	PLYMOUTH	PROWLER	17"	19"	Metal
1981	1989	PLYMOUTH	RELIANT	16"	16"	Metal
1978	1983	PLYMOUTH	SAPPORO	17"	17"	Metal
1983	1984	PLYMOUTH	SCAMP	16"	16"	Metal
1987	1994	PLYMOUTH	SUNDANCE	18"	18"	Metal
1982	1987	PLYMOUTH	TURISMO	16"	16"	Metal
1975	1990	PLYMOUTH	VAN (FULL SIZE)	16"	16"	Metal
1984	1992	PLYMOUTH	VOYAGER	18"	18"	Metal
1993	1995	PLYMOUTH	VOYAGER	22"	18"	Metal
1996	2000	PLYMOUTH	VOYAGER	28"	28"	Metal
1984	1991	PONTIAC	6000	18"	18"	Metal
2001	2005	PONTIAC	AZTEK	24"	24"	Metal
1968	1986	PONTIAC	BONNEVILLE	18"	18"	Metal
1987	1991	PONTIAC	BONNEVILLE	19"	19"	Metal
1992	2005	PONTIAC	BONNEVILLE	22"	22"	Metal
1968	1981	PONTIAC	CATALINA	18"	18"	Metal
1984	1988	PONTIAC	FIERO	18"	18"	Metal
1970	1981	PONTIAC	FIREBIRD	18"	18"	Metal
1982	1992	PONTIAC	FIREBIRD	18"	18"	Metal
1993	2001	PONTIAC	FIREBIRD	24"	24"	Metal
1987	1991	PONTIAC	FIREFLY (CN)	20"	18"	Metal
2009	2009	PONTIAC	G3	22"	18"	Metal
2007	2009	PONTIAC	G5	22"	17"	Metal
2005	2010	PONTIAC	G6	24"	21"	Beam
2008	2009	PONTIAC	G8	26"	15"	Beam
1978	1981	PONTIAC	GRAND AM	18"	18"	Metal

AUTOMOTIVE APPLICATION GUIDE

00

AUTOMOTIVE APPLICATION GUIDE

START	END	MAKE	MODEL	DS	PS	TYPE
1982	1997	PONTIAC	GRAND AM	19"	19"	Metal
1998	2005	PONTIAC	GRAND AM	22"	17"	Metal
1978	1987	PONTIAC	GRAND PRIX	18"	18"	Metal
1988	1996	PONTIAC	GRAND PRIX	20"	20"	Metal
1997	2005	PONTIAC	GRAND PRIX	22"	22"	Metal
2006	2008	PONTIAC	GRAND PRIX	22"	22"	Beam
2004	2006	PONTIAC	GTO	22"	20"	Metal
1982	1986	PONTIAC	J2000	16"	16"	Metal
1978	1993	PONTIAC	LEMANS	18"	18"	Metal
1998	2005	PONTIAC	MONTANA	24"	24"	Metal
2005	2006	PONTIAC	MONTANA SV6	24"	22"	Metal
1983	1988	PONTIAC	PARISIENNE	18"	18"	Metal
1980	1984	PONTIAC	PHOENIX	18"	18"	Metal
2006	2009	PONTIAC	SOLSTICE	16"	22"	Metal
1976	1989	PONTIAC	SUNBIRD	16"	16"	Metal
1990	1994	PONTIAC	SUNBIRD	17"	17"	Metal
1995	2005	PONTIAC	SUNFIRE	22"	17"	Metal
1981	1987	PONTIAC	T1000	16"	16"	Metal
1987	1991	PONTIAC	TEMPEST	18"	18"	Metal
2006	2009	PONTIAC	TORRENT	24"	19"	Metal
1990	1996	PONTIAC	TRANS SPORT	24"	24"	Metal
1997	1998	PONTIAC	TRANS SPORT	24"	24"	Metal
2003	2008	PONTIAC	VIBE	21"	18"	Metal
2009	2010	PONTIAC	VIBE	26"	17"	Beam
1966	1994	PORSCHE	911	13"	13"	Metal
1995	1997	PORSCHE	911	15"	18"	Metal
1998	2013	PORSCHE	911	22"	22"	Metal
1977	1983	PORSCHE	924	20"	20"	Metal
1981	1991	PORSCHE	928	20"	20"	Metal
1992	1995	PORSCHE	928	19"	19"	Metal
1983	1991	PORSCHE	944	20"	20"	Metal
1992	1995	PORSCHE	968	19"	19"	Metal
1998	2012	PORSCHE	BOXTER	22"	22"	Metal
2004	2010	PORSCHE	CAYENNE	26"	26"	Beam
2007	2009	PORSCHE	CAYMAN	22"	22"	Metal
2010	2012	PORSCHE	PANAMERA	22"	22"	Metal
1994	2005	ROVER	DEFENDER	13"	13"	Metal
1995	1995	ROVER	DISCOVERY	18"	18"	Metal
1995	1995	ROVER	RANGE ROVER	22"	22"	Metal
1978	1989	ROVER	RANGE ROVER CLASSIC	17"	17"	Metal
1990	1995	ROVER	RANGE ROVER CLASSIC	18"	18"	Metal

AUTOMOTIVE APPLICATION GUIDE

START	END	MAKE	MODEL	DS	PS	TYPE
1979	1993	SAAB	900	16"	16"	Metal
1994	1997	SAAB	900	21"	21"	Metal
1991	1994	SAAB	900 CONVERTIBLE	18"	18"	Metal
1986	1998	SAAB	9000	21"	21"	Metal
2004	2006	SAAB	9-2X	22"	17"	Metal
1998	2002	SAAB	3-SEP	21"	21"	Metal
2003	2007	SAAB	3-SEP	22"	22"	Metal
2008	2011	SAAB	3-SEP	22"	22"	Beam
2011	2011	SAAB	9-4X	26"	17"	Beam
1998	2007	SAAB	5-SEP	23"	23"	Metal
2008	2009	SAAB	5-SEP	22"	22"	Metal
2010	2011	SAAB	5-SEP	24"	21"	Beam
2006	2009	SAAB	9-7X	22"	22"	Metal
1991	2002	SATURN	ALL (EXCEPT L-SERIES)	22"	21"	Metal
2008	2009	SATURN	ASTRA	22"	18"	Beam
2007	2010	SATURN	AURA	24"	21"	Beam
2003	2007	SATURN	ION	22"	19"	Metal
2000	2004	SATURN	L-SERIES	19"	19"	Metal
2007	2010	SATURN	OUTLOOK	24"	21"	Beam
2005	2006	SATURN	RELAY	24"	24"	Metal
2007	2009	SATURN	SKY	24"	22"	Metal
2002	2007	SATURN	VUE	24"	19"	Metal
2008	2010	SATURN	VUE	24"	16"	Metal
2013	2013	SCION	FR-S	22"	20"	Beam
2012	2012	SCION	iQ	24"	18"	Beam
2005	2010	SCION	tC	26"	16"	Metal
2011	2013	SCION	tC	24"	18"	Beam
2004	2007	SCION	xA	24"	16"	Metal
2004	2007	SCION	xB	20"	20"	Metal
2008	2013	SCION	xB	22"	20"	Beam
2008	2013	SCION	xD	26"	14"	Beam
2008	2013	SMART	FORTWO	22"	21"	Beam
1987	1991	STERLING	825/827	19"	19"	Metal
2003	2006	SUBARU	BAJA	22"	20"	Metal
1978	1981	SUBARU	BRAT	13"	13"	Metal
1982	1987	SUBARU	BRAT	17"	17"	Metal
2013	2013	SUBARU	BRZ	22"	20"	Beam
1986	1990	SUBARU	DL, GL	17"	17"	Metal
1980	1985	SUBARU	DL, GL, GLF	17"	17"	Metal
1998	2007	SUBARU	FORESTER	22"	19"	Metal
2008	2008	SUBARU	FORESTER	22"	19"	Metal

AUTOMOTIVE APPLICATION GUIDE

00

AUTOMOTIVE APPLICATION GUIDE

START	END	MAKE	MODEL	DS	PS	TYPE
2009	2012	SUBARU	FORESTER	24"	18"	Beam
1993	2001	SUBARU	IMPREZA	21"	18"	Metal
2002	2003	SUBARU	IMPREZA	20"	17"	Metal
2004	2007	SUBARU	IMPREZA	22"	17"	Metal
2008	2011	SUBARU	IMPREZA	24"	16"	Metal
2012	2013	SUBARU	IMPREZA	26"	16"	Metal
1987	1988	SUBARU	JUSTY	17"	17"	Metal
1989	1994	SUBARU	JUSTY	18"	17"	Metal
1989	1994	SUBARU	LEGACY	20"	18"	Metal
1995	2004	SUBARU	LEGACY	21"	19"	Metal
2005	2009	SUBARU	LEGACY	24"	18"	Metal
2010	2013	SUBARU	LEGACY	26"	19"	Beam
1990	1994	SUBARU	LOYALE	19"	19"	Metal
1996	2004	SUBARU	OUTBACK	21"	19"	Metal
2005	2009	SUBARU	OUTBACK	24"	18"	Metal
2010	2013	SUBARU	OUTBACK	26"	19"	Beam
1989	1990	SUBARU	RX COUPE	17"	17"	Metal
1991	1991	SUBARU	RX COUPE	19"	19"	Metal
1992	1997	SUBARU	SVX	22"	20"	Metal
2008	2009	SUBARU	TRIBECA	-	20"	Metal
2010	2012	SUBARU	TRIBECA	26"	20"	Metal
2002	2008	SUZUKI	AERIO	22"	18"	Metal
2009	2012	SUZUKI	EQUATOR	24"	18"	Metal
1995	2002	SUZUKI	ESTEEM	20"	18"	Metal
2004	2008	SUZUKI	FORENZA	22"	19"	Metal
1987	1988	SUZUKI	FORSA	17"	17"	Metal
2006	2012	SUZUKI	GRAND VITARA	19"	19"	Metal
2010	2012	SUZUKI	KIZASHI	24"	20"	Beam
2005	2008	SUZUKI	RENO	22"	19"	Metal
1986	1995	SUZUKI	SAMURAI	13"	13"	Metal
1989	1998	SUZUKI	SIDEKICK	17"	17"	Metal
1989	2001	SUZUKI	SWIFT	20"	18"	Metal
2007	2010	SUZUKI	SX4	26"	16"	Metal
2004	2005	SUZUKI	VERONA	22"	20"	Metal
1999	2005	SUZUKI	VITARA, GRAND VITARA	19"	19"	Metal
1997	1998	SUZUKI	X-90	17"	18"	Metal
2001	2006	SUZUKI	XL-7	19"	19"	Metal
2007	2009	SUZUKI	XL-7	24"	19"	Metal
1993	2002	TOYOTA	4-RUNNER	17"	17"	Metal
2003	2009	TOYOTA	4-RUNNER	22"	20"	Metal
2010	2013	TOYOTA	4-RUNNER	24"	20"	Beam

AUTOMOTIVE APPLICATION GUIDE

START	END	MAKE	MODEL	DS	PS	TYPE
1995	1999	TOYOTA	AVALON	21"	19"	Metal
2000	2004	TOYOTA	AVALON	24"	17"	Metal
2005	2013	TOYOTA	AVALON	26"	20"	Beam
1983	1986	TOYOTA	CAMRY	19"	19"	Metal
1987	1991	TOYOTA	CAMRY	19"	17"	Metal
1992	2001	TOYOTA	CAMRY	21"	19"	Metal
2002	2006	TOYOTA	CAMRY	24"	19"	Metal
2007	-	TOYOTA	CAMRY	24"	20"	Beam
-	2013	TOYOTA	CAMRY	26"	18"	Beam
1980	1985	TOYOTA	CELICA	17"	17"	Metal
1986	1989	TOYOTA	CELICA	19"	17"	Metal
1990	1993	TOYOTA	CELICA	19"	19"	Metal
1994	1999	TOYOTA	CELICA	21"	20"	Metal
2000	2005	TOYOTA	CELICA	26"	17"	Metal
1978	1986	TOYOTA	COROLLA	17"	17"	Metal
1987	1992	TOYOTA	COROLLA	19"	17"	Metal
1993	2002	TOYOTA	COROLLA	20"	18"	Metal
2003	2008	TOYOTA	COROLLA	24"	18"	Metal
2009	2013	TOYOTA	COROLLA	26"	16"	Beam
1978	1981	TOYOTA	CORONA	17"	17"	Metal
1978	1984	TOYOTA	CRESSIDA	17"	17"	Metal
1985	1992	TOYOTA	CRESSIDA	19"	19"	Metal
2000	2008	TOYOTA	ECHO	22"	14"	Metal
2007	2012	TOYOTA	FJ CRUISER	16"	-	Metal
2001	2007	TOYOTA	HIGHLANDER	22"	19"	Metal
2008	2012	TOYOTA	HIGHLANDER	26"	20"	Beam
1978	1982	TOYOTA	LANDCRUISER	11"	11"	Metal
1983	1990	TOYOTA	LANDCRUISER	17"	17"	Metal
1991	1992	TOYOTA	LANDCRUISER	19"	19"	Metal
1993	1997	TOYOTA	LANDCRUISER	18"	18"	Metal
1998	2003	TOYOTA	LANDCRUISER	20"	20"	Metal
2004	2007	TOYOTA	LANDCRUISER	24"	22"	Metal
2008	2013	TOYOTA	LANDCRUISER	24"	22"	Beam
2003	2008	TOYOTA	MATRIX	21"	18"	Metal
2009	2013	TOYOTA	MATRIX	26"	16"	Beam
1985	2005	TOYOTA	MR2	19"	19"	Metal
1992	1999	TOYOTA	PASEO	20"	18"	Metal
1979	2002	TOYOTA	PICKUP, 4-RUNNER	17"	17"	Metal
2001	2003	TOYOTA	PRIUS (ALL)	24"	17"	Metal
2004	2009	TOYOTA	PRIUS (ALL)	26"	18"	Metal
2010	2013	TOYOTA	PRIUS (ALL)	26"	19"	Beam

AUTOMOTIVE APPLICATION GUIDE



AUTOMOTIVE APPLICATION GUIDE

START	END	MAKE	MODEL	DS	PS	TYPE
2012	2013	TOYOTA	PRIUS-C	28"	14"	Beam
1996	2000	TOYOTA	RAV4	20"	18"	Metal
2001	2005	TOYOTA	RAV4	22"	19"	Metal
2006	2013	TOYOTA	RAV4	24"	16"	Metal
2001	2007	TOYOTA	SEQUOIA	19"	19"	Metal
2008	2013	TOYOTA	SEQUOIA	26"	22"	Beam
1998	2003	TOYOTA	SIENNA	24"	18"	Metal
2004	2009	TOYOTA	SIENNA	26"	19"	Metal
2010	2013	TOYOTA	SIENNA	28"	20"	Beam
1999	2003	TOYOTA	SOLARA	22"	21"	Metal
2004	2008	TOYOTA	SOLARA	24"	19"	Metal
1981	1983	TOYOTA	STARLET	17"	17"	Metal
1980	1985	TOYOTA	SUPRA	17"	17"	Metal
1986	1988	TOYOTA	SUPRA	19"	17"	Metal
1989	1993	TOYOTA	SUPRA	19"	19"	Metal
1994	1998	TOYOTA	SUPRA	21"	19"	Metal
1993	1998	TOYOTA	T-100	19"	19"	Metal
1995	2004	TOYOTA	TACOMA	17"	17"	Metal
2005	2013	TOYOTA	TACOMA	22"	21"	Metal
1980	1982	TOYOTA	TERCEL	15"	15"	Metal
1983	1986	TOYOTA	TERCEL	17"	17"	Metal
1987	1990	TOYOTA	TERCEL	19"	17"	Metal
1991	1997	TOYOTA	TERCEL	18"	18"	Metal
2000	2006	TOYOTA	TUNDRA	19"	19"	Metal
2007	2013	TOYOTA	TUNDRA	24"	22"	Beam
1984	1989	TOYOTA	VAN	17"	17"	Metal
2009	2012	TOYOTA	VENZA	26"	22"	Beam
2007	2011	TOYOTA	YARIS	26"	14"	Metal
2012	2012	TOYOTA	YARIS	28"	-	Beam
1998	2011	VOLKSWAGEN	BEETLE	21"	21"	Metal
2012	2013	VOLKSWAGEN	BEETLE	22"	22"	Beam
1995	2002	VOLKSWAGEN	CABRIO	21"	19"	Metal
1985	1993	VOLKSWAGEN	CABRIOLET	16"	16"	Metal
2012	2012	VOLKSWAGEN	CC	24"	19"	Beam
1990	1994	VOLKSWAGEN	CORRADO	19"	19"	Metal
1974	1981	VOLKSWAGEN	DASHER	16"	16"	Metal
2007	2012	VOLKSWAGEN	EOS	24"	19"	Beam
1992	2003	VOLKSWAGEN	EUROVAN	21"	21"	Metal
1987	1993	VOLKSWAGEN	FOX	18"	18"	Metal
1985	1987	VOLKSWAGEN	GOLF/GTI	18"	18"	Metal
1988	1992	VOLKSWAGEN	GOLF/GTI	16"	16"	Metal

AUTOMOTIVE APPLICATION GUIDE

START	END	MAKE	MODEL	DS	PS	TYPE
1993	2006	VOLKSWAGEN	GOLF/GTI	21"	19"	Metal
2010	2013	VOLKSWAGEN	GOLF/GTI	24"	19"	Beam
1993	-	VOLKSWAGEN	JETTA	21"	19"	Metal
1985	1992	VOLKSWAGEN	JETTA (EXCEPT GLI)	16"	16"	Metal
-	2013	VOLKSWAGEN	JETTA	24"	20"	Beam
1985	1992	VOLKSWAGEN	JETTA GLI	18"	18"	Metal
1990	2001	VOLKSWAGEN	PASSAT	21"	21"	Metal
2002	2005	VOLKSWAGEN	PASSAT	21"	21"	Beam
2006	2013	VOLKSWAGEN	PASSAT	24"	19"	Beam
2009	2012	VOLKSWAGEN	PASSAT CC	24"	19"	Beam
2004	2006	VOLKSWAGEN	PHAETON	24"	21"	Beam
1980	1983	VOLKSWAGEN	PICKUP	16"	16"	Metal
1983	1988	VOLKSWAGEN	QUANTUM	18"	18"	Metal
2008	2009	VOLKSWAGEN	R32	24"	19"	Beam
1975	1984	VOLKSWAGEN	RABBIT	16"	16"	Metal
2007	2009	VOLKSWAGEN	RABBIT/GTI	24"	19"	Beam
2009	2012	VOLKSWAGEN	ROUTAN	26"	20"	Metal
1975	1981	VOLKSWAGEN	SCIROCCO	17"	17"	Metal
1982	1988	VOLKSWAGEN	SCIROCCO	19"	19"	Metal
2009	2012	VOLKSWAGEN	TIGUAN	24"	21"	Beam
2004	2012	VOLKSWAGEN	TOUAREG	26"	26"	Beam
1980	1991	VOLKSWAGEN	VANAGON	18"	18"	Metal
1975	1984	VOLVO	240-SERIES	16"	16"	Metal
1985	1993	VOLVO	240-SERIES	17"	17"	Metal
1985	1992	VOLVO	740	20"	20"	Metal
1984	1988	VOLVO	760	20"	20"	Metal
1989	1990	VOLVO	760	21"	21"	Metal
1988	1991	VOLVO	780	20"	20"	Metal
1993	1997	VOLVO	850	21"	21"	Metal
1991	1995	VOLVO	940	20"	20"	Metal
1991	1997	VOLVO	960	21"	21"	Metal
2008	2012	VOLVO	C30	26"	20"	Beam
1997	2006	VOLVO	C70	21"	21"	Metal
2007	2013	VOLVO	C70	26"	19"	Beam
1999	2004	VOLVO	S40	21"	20"	Metal
2005	2011	VOLVO	S40	26"	20"	Beam
2001	2004	VOLVO	S60	24"	21"	Metal
2005	2009	VOLVO	S60	24"	22"	Beam
2010	2013	VOLVO	S60	26"	20"	Beam
1997	2002	VOLVO	S70	21"	21"	Metal
1999	2004	VOLVO	S80	24"	22"	Metal

AUTOMOTIVE APPLICATION GUIDE



AUTOMOTIVE APPLICATION GUIDE

START	END	MAKE	MODEL	DS	PS	TYPE
2005	2013	VOLVO	S80	24"	22"	Beam
1997	2002	VOLVO	S90	21"	21"	Metal
1999	2003	VOLVO	V40-WAGON	21"	20"	Metal
2005	2011	VOLVO	V50	26"	20"	Beam
1997	2000	VOLVO	V70-WAGON	21"	21"	Metal
2001	2004	VOLVO	V70-WAGON	24"	22"	Metal
2005	2007	VOLVO	V70-WAGON	24"	22"	Beam
2008	2010	VOLVO	V70-WAGON	26"	19"	Beam
1997	1998	VOLVO	V90-WAGON	21"	21"	Metal
2010	2012	VOLVO	XC60	26"	20"	Beam
2002	2004	VOLVO	XC70	24"	22"	Metal
2005	2007	VOLVO	XC70	26"	22"	Beam
2008	2013	VOLVO	XC70	26"	20"	Beam
2002	2004	VOLVO	XC90	24"	22"	Metal
2005	2013	VOLVO	XC90	24"	22"	Beam
1986	1992	YUGO	ALL	16"	16"	Metal

HEAVY-DUTY APPLICATION GUIDE

9



HEAVY-DUTY APPLICATION GUIDE

9

TRUCK

START	END	MAKE	MODEL	UNIVERSAL	HEAVY-DUTY	WINTER
1969	1977	AUTOCAR	A1, AU & DC	-	ABP N82 7216	ABP N82 WN16
1988	1995	AUTOCAR	AC-SERIES	ABP N82 7620	-	ABP N82 W20
1957	1970	AUTOCAR	ALL OTHER MODELS	-	ABP N82 7215	ABP N82 WN15
1975	1985	AUTOCAR	ALL OTHER MODELS	-	ABP N82 7216	ABP N82 WN16
1970	1974	AUTOCAR	ALL WITH FLAT TAPERED SHAFT	ABP N82 7616	-	ABP N82 W16
1982	1988	AUTOCAR	AT-SERIES	-	ABP N82 7218	ABP N82 WN18
1978	1982	AUTOCAR	CONSTRUCKTOR II	-	ABP N82 7220	ABP N82 WN20
1999	2001	BERING	HD-SERIES	ABP N82 7622	-	ABP N82 W22
1999	2000	BERING	LD-SERIES	ABP N82 7620	-	ABP N82 W20
1999	2000	BERING	MD-SERIES	ABP N82 7622	-	ABP N82 W22
1965	1977	BROCKWAY	400-SERIES 50 & 80 CABS	-	ABP N82 7220	ABP N82 WN20
1973	1977	BROCKWAY	700-SERIES	-	ABP N82 7216	ABP N82 WN16
1997	2002	CAPACITY	TJ-SERIES	-	ABP N82 7828	ABP N82 W28
1970	1986	CAPACITY	TRAILER JOCKEY	-	ABP N82 7122	ABP N82 WN22
1997	2002	CAPACITY	YM-SERIES	-	ABP N82 7828	ABP N82 W28
1977	1985	CHEVROLET	BISON	-	ABP N82 7215	ABP N82 WN15
1978	1980	CHEVROLET	BRUIN	ABP N82 7616	-	ABP N82 W16
1967	1972	CHEVROLET	C40, C50 & C60	ABP N82 7615	-	ABP N82 W15
2003	2007	CHEVROLET	C4500, C5500, C6500, C7500 & C8500	ABP N82 7622	-	ABP N82 W22
2007	2009	CHEVROLET	C4500, C5500, C6500, C7500 & C8500	ABP N82 7622	-	ABP N82 W22
1973	1989	CHEVROLET	C50, C60 & C70	ABP N82 7616	-	ABP N82 W16
1996	2002	CHEVROLET	C5500, C6500, C7500 & C8500	ABP N82 7618	-	ABP N82 W18
1965	1984	CHEVROLET	G-SERIES (ALL)	ABP N82 7616	-	ABP N82 W16
1993	1995	CHEVROLET	G-SERIES (ALL)	ABP N82 7618	-	ABP N82 W18
1996	1998	CHEVROLET	G-SERIES (ALL)	ABP N82 7622	-	ABP N82 W22

HEAVY-DUTY APPLICATION GUIDE

START	END	MAKE	MODEL	UNIVERSAL	HEAVY-DUTY	WINTER
1966	1979	CHEVROLET	H & J-SERIES & M-SERIES	ABP N82 7616	-	ABP N82 W16
1990	1996	CHEVROLET	KODIAK	ABP N82 7618	-	ABP N82 W18
1960	1972	CHEVROLET	N50, N60 & N90	-	ABP N82 7218	ABP N82 WN18
1960	1972	CHEVROLET	T40 THRU T80	-	ABP N82 7218	ABP N82 WN18
1973	1980	CHEVROLET	T50 THRU T80	ABP N82 7618	-	ABP N82 W18
1996	2007	CHEVROLET	T5500, T6500, T7500 & T8500	ABP N82 7622	-	ABP N82 W22
2007	2009	CHEVROLET	T5500, T6500, T7500 & T8500	ABP N82 7622	-	ABP N82 W22
1984	1985	CHEVROLET	TILTMASER	ABP N82 7618	-	ABP N82 W18
1986	1994	CHEVROLET	TILTMASER	ABP N82 7619	-	ABP N82 W18
1995	2004	CHEVROLET	TILTMASER	ABP N82 7620	-	ABP N82 W20
1971	1980	CHEVROLET	TITAN	-	ABP N82 7826	ABP N82 W26
1960	1972	CHEVROLET	U80	-	ABP N82 7218	ABP N82 WN18
1973	1980	CHEVROLET	W70 & W80	ABP N82 7618	-	ABP N82 W18
1960	1972	CHEVROLET	W80	-	ABP N82 7218	ABP N82 WN18
1960	1972	CHEVROLET	Y60	-	ABP N82 7218	ABP N82 WN18
1980	1985	CRANE CARRIER	B, D, LE & M-SERIES	-	ABP N82 7122	ABP N82 WN22
1981	1984	CRANE CARRIER	CENTURY II	-	ABP N82 7118	ABP N82 WN18
1976	1985	CRANE CARRIER	F-SERIES CENTURION	-	ABP N82 7118	ABP N82 WN18
1992	2001	DAF	65, 75 & 85-SERIES	ABP N82 7624	-	ABP N82 W24
1997	2001	DAF	95-SERIES	ABP N82 7622	-	ABP N82 W22
2002	2002	DAF	LF-SERIES	ABP N82 7624	-	ABP N82 W24
1972	1974	DIAMOND REO	C116, C119 & DC101	ABP N82 7616	-	ABP N82 W16
1972	1974	DIAMOND REO	C116, C119 & DC101	-	ABP N82 7216	ABP N82 WN16
1968	1974	DIAMOND REO	C90 & C101	ABP N82 7613	-	ABP N82 W13
1968	1972	DIAMOND REO	C90D & C114	-	ABP N82 7215	ABP N82 WN15



TRUCK

HEAVY-DUTY APPLICATION GUIDE

9

TRUCK

START	END	MAKE	MODEL	UNIVERSAL	HEAVY-DUTY	WINTER
1971	1974	DIAMOND REO	CF59 & CF65	-	ABP N82 7118	ABP N82 WN18
1974	1974	DIAMOND REO	CF60	-	ABP N82 7121	ABP N82 WN20
1956	1972	DIAMOND REO	CO50 & CO78	-	ABP N82 7116	ABP N82 WN16
1973	1975	DIAMOND REO	CO54 & CO88 (DBL ARM)	-	ABP N82 7216	ABP N82 WN16
1974	1974	DIAMOND REO	CO54 & CO88 (SNGL ARM)	-	ABP N82 7218	ABP N82 WN18
1981	1988	DIAMOND REO	GIANT	-	ABP N82 7216	ABP N82 WN16
1968	1971	DIAMOND REO	HF3000	-	ABP N82 7120	ABP N82 WN20
1998	2001	DINA	HTQ	ABP N82 7622	-	ABP N82 W22
1971	1994	DODGE	B-SERIES	ABP N82 7616	-	ABP N82 W16
1995	1998	DODGE	B-SERIES	ABP N82 7618	-	ABP N82 W18
1969	1974	DODGE	D & W-SERIES	ABP N82 7613	-	ABP N82 W13
1966	1975	DODGE	L1000	-	ABP N82 7120	ABP N82 WN20
2007	2010	DODGE	SPRINTER	ABP N82 7626	-	ABP N82 W26
1989	1995	FORD	AEROMAX	-	ABP N82 7218	ABP N82 WN18
1996	1998	FORD	AEROMAX & AEROVIEW	ABP N82 7620	-	ABP N82 W20
1961	1989	FORD	C-SERIES (DBL ARM)	-	ABP N82 7216	ABP N82 WN16
1961	1987	FORD	C-SERIES (SNGL ARM)	-	ABP N82 7218	ABP N82 WN18
1986	1998	FORD	CARGO	-	ABP N82 7826	ABP N82 W26
1968	1974	FORD	E-100/300	ABP N82 7618	-	ABP N82 W18
1975	1980	FORD	E-100/300	ABP N82 7619	-	ABP N82 W18
1981	1991	FORD	E-100/300	ABP N82 7618	-	ABP N82 W18
1992	1997	FORD	E-100/300	ABP N82 7622	-	ABP N82 W22
1998	1998	FORD	E-100/300	ABP N82 7620	-	ABP N82 W20
1967	1979	FORD	F-SERIES	ABP N82 7615	-	ABP N82 W15
1980	1997	FORD	F-SERIES	ABP N82 7618	-	ABP N82 W18

HEAVY-DUTY APPLICATION GUIDE

START	END	MAKE	MODEL	UNIVERSAL	HEAVY-DUTY	WINTER
1998	1999	FORD	F-SERIES	ABP N82 7622	-	ABP N82 W22
2000	2003	FORD	F-SERIES	ABP N82 7620	-	ABP N82 W20
2000	2012	FORD	F-SERIES	ABP N82 7622	-	ABP N82 W20
2007	2012	FORD	F-SERIES	ABP N82 7622	-	ABP N82 W22
1970	1995	FORD	L-SERIES	-	ABP N82 7218	ABP N82 WN18
1996	1998	FORD	L-SERIES	ABP N82 7620	-	ABP N82 W20
2007	2009	FORD	LCF	ABP N82 7620	-	ABP N82 W20
2006	2007	FORD	LCF D.S.	ABP N82 7621	-	ABP N82 W20
2006	2007	FORD	LCF P.S.	ABP N82 7620	-	ABP N82 W20
1996	1997	FORD	LN & LTN-SERIES	-	ABP N82 7218	ABP N82 WN18
1966	1973	FORD	W-SERIES	-	ABP N82 7120	ABP N82 WN20
1974	1977	FORD	W-SERIES	-	ABP N82 7119	ABP N82 WN18
1998	1998	FREIGHTLINER	AMERICAN LAFRANCE	-	ABP N82 7422	ABP N82 W22
1999	2006	FREIGHTLINER	ARGOSY	ABP N82 7621	-	ABP N82 W20
2007	2012	FREIGHTLINER	BUSINESS CLASS M2	ABP N82 7622	-	ABP N82 W22
1996	2006	FREIGHTLINER	C 112 & C120	ABP N82 7622	-	ABP N82 W22
2008	2012	FREIGHTLINER	CASCADIA	ABP N82 7624	-	ABP N82 W24
2007	2010	FREIGHTLINER	CENTURY CLASS (C112, C120)	ABP N82 7622	-	ABP N82 W22
1997	1997	FREIGHTLINER	CL 120 (2PC)	ABP N82 7622	-	ABP N82 W22
1997	1997	FREIGHTLINER	CL 120 (DRIVER-1PC)	ABP N82 7624	-	ABP N82 W24
1997	1997	FREIGHTLINER	CL 120 (PASSENGER-1PC)	ABP N82 7622	-	ABP N82 W22
1993	1994	FREIGHTLINER	CLASSIC XL	-	ABP N82 7215	ABP N82 WN15
1995	2003	FREIGHTLINER	CLASSIC XL	-	ABP N82 7115	ABP N82 WN15
1995	2008	FREIGHTLINER	CLASSIC XL	-	ABP N82 7115	ABP N82 WN15
2007	2009	FREIGHTLINER	CLASSIC XL	-	ABP N82 7115	-



TRUCK

HEAVY-DUTY APPLICATION GUIDE

9

TRUCK

START	END	MAKE	MODEL	UNIVERSAL	HEAVY-DUTY	WINTER
2000	2003	FREIGHTLINER	COLUMBIA	ABP N82 7622	-	ABP N82 W22
2007	2011	FREIGHTLINER	COLUMBIA	ABP N82 7622	-	ABP N82 W22
2001	2003	FREIGHTLINER	CORONADO	ABP N82 7622	-	ABP N82 W22
2007	2012	FREIGHTLINER	CORONADO	ABP N82 7622	-	ABP N82 W22
1998	1998	FREIGHTLINER	FC CARGO	-	ABP N82 7726	ABP N82 W26
1991	2003	FREIGHTLINER	FL-SERIES	ABP N82 7624	-	ABP N82 W24
1989	1993	FREIGHTLINER	FLA	-	ABP N82 7114	ABP N82 WN13
1994	1997	FREIGHTLINER	FLB	-	ABP N82 7114	ABP N82 WN13
1976	1988	FREIGHTLINER	FLC-SERIES	-	ABP N82 7115	ABP N82 WN15
1989	1994	FREIGHTLINER	FLC-SERIES	-	ABP N82 7215	ABP N82 WN15
1995	1998	FREIGHTLINER	FLC-SERIES	-	ABP N82 7115	ABP N82 WN15
1989	1994	FREIGHTLINER	FLD-SERIES	-	ABP N82 7215	ABP N82 WN15
1995	2003	FREIGHTLINER	FLD-SERIES	-	ABP N82 7115	ABP N82 WN15
2007	2009	FREIGHTLINER	FLD-SERIES	-	ABP N82 7115	-
1998	1998	FREIGHTLINER	FLH	ABP N82 7621	-	ABP N82 W20
1989	1997	FREIGHTLINER	FLL	-	ABP N82 7114	ABP N82 WN13
1959	1971	FREIGHTLINER	FLT	-	ABP N82 7116	ABP N82 WN16
1972	1988	FREIGHTLINER	FLT	-	ABP N82 7115	ABP N82 WN15
2002	2003	FREIGHTLINER	M2	ABP N82 7622	-	ABP N82 W22
1991	1995	FREIGHTLINER	MB-SERIES	ABP N82 7624	-	ABP N82 W24
1999	2001	FREIGHTLINER	SPORT CHASSIS	ABP N82 7624	-	ABP N82 W24
1972	1977	FWD	CA-64, CB-66 & CC66	-	ABP N82 7116	ABP N82 WN16
1986	1986	FWD	REFUSE TRUCK	ABP N82 7620	-	ABP N82 W20
1984	1984	FWD	RO-SERIES	-	ABP N82 7116	ABP N82 WN16
1971	1981	GMC	7000 THRU 9500	ABP N82 7616	-	ABP N82 W16

HEAVY-DUTY APPLICATION GUIDE

START	END	MAKE	MODEL	UNIVERSAL	HEAVY-DUTY	WINTER
1969	1987	GMC	ASTRO	-	ABP N82 7826	ABP N82 W26
1978	1987	GMC	BRIGADIER	ABP N82 7616	-	ABP N82 W16
1971	1989	GMC	C4500 THRU 9500	ABP N82 7616	-	ABP N82 W16
1970	1972	GMC	C4500, 5500 & 6500	ABP N82 7615	-	ABP N82 W15
2003	2007	GMC	C4500, C5500, C6500, C7500 & C8500	ABP N82 7622	-	ABP N82 W22
2007	2009	GMC	C4500, C5500, C6500, C7500 & C8500	ABP N82 7622	-	ABP N82 W22
1973	1989	GMC	C5000, C6000 & C7000	-	ABP N82 7114	ABP N82 WN13
1996	2002	GMC	C5500 THRU 8500	ABP N82 7618	-	ABP N82 W18
2003	2003	GMC	C5500 THRU 8500	ABP N82 7622	-	ABP N82 W22
1990	1990	GMC	C7HO42	ABP N82 7618	-	ABP N82 W18
1970	1978	GMC	E4500, 5500 & 6500	ABP N82 7616	-	ABP N82 W16
2005	2007	GMC	FORWARD (W3500, W4500, W5500)	ABP N82 7620	-	ABP N82 W20
2007	2010	GMC	FORWARD (W3500, W4500, W5500)	ABP N82 7620	-	ABP N82 W20
1984	1985	GMC	FORWARD, W4-W7	ABP N82 7618	-	ABP N82 W18
1986	1994	GMC	FORWARD, W4-W7	ABP N82 7619	-	ABP N82 W18
1995	2003	GMC	FORWARD, W4-W7	ABP N82 7620	-	ABP N82 W20
1977	1987	GMC	GENERAL	-	ABP N82 7215	ABP N82 WN15
1964	1992	GMC	G-SERIES	ABP N82 7616	-	ABP N82 W16
1993	1995	GMC	G-SERIES	ABP N82 7618	-	ABP N82 W18
1996	1998	GMC	G-SERIES	ABP N82 7622	-	ABP N82 W22
1966	1979	GMC	H, J, & M-SERIES	ABP N82 7616	-	ABP N82 W16
1960	1972	GMC	L-SERIES	-	ABP N82 7218	ABP N82 WN18
1960	1972	GMC	T & W-SERIES	-	ABP N82 7218	ABP N82 WN18
1973	1980	GMC	T & W-SERIES	ABP N82 7618	-	ABP N82 W18



TRUCK

HEAVY-DUTY APPLICATION GUIDE

9

TRUCK

START	END	MAKE	MODEL	UNIVERSAL	HEAVY-DUTY	WINTER
2007	2009	GMC	T550, T6500, T7500 & T8500	ABP N82 7622	-	ABP N82 W22
1981	2003	GMC	T5500 THRU 8500	ABP N82 7622	-	ABP N82 W22
1990	1996	GMC	TOPKICK	ABP N82 7618	-	ABP N82 W18
2005	2005	HINO	ALL MODELS	ABP N82 7622	-	ABP N82 W22
2006	2012	HINO	ALL MODELS	ABP N82 7626	-	ABP N82 W26
1985	1997	HINO	FD, FE, FF & SG-SERIES	ABP N82 7619	-	ABP N82 W18
2002	2006	HUMMER	H2	ABP N82 7616	-	ABP N82 W16
2006	2007	HUMMER	H3 D.S.	ABP N82 7617	-	ABP N82 W16
2006	2007	HUMMER	H3 P.S.	ABP N82 7616	-	ABP N82 W16
2006	2007	INTERNATIONAL/ NAVISTAR	4100	ABP N82 7622	-	ABP N82 W22
2007	2007	INTERNATIONAL/ NAVISTAR	4100	ABP N82 7622	-	ABP N82 W22
2007	2007	INTERNATIONAL/ NAVISTAR	4200	ABP N82 7622	-	ABP N82 W22
1978	1981	INTERNATIONAL/ NAVISTAR	4300	-	ABP N82 7216	ABP N82 WN16
2007	2007	INTERNATIONAL/ NAVISTAR	4300	ABP N82 7622	-	ABP N82 W22
2007	2007	INTERNATIONAL/ NAVISTAR	4400	ABP N82 7622	-	ABP N82 W22
2007	2007	INTERNATIONAL/ NAVISTAR	7300	ABP N82 7622	-	ABP N82 W22
2007	2007	INTERNATIONAL/ NAVISTAR	7400	ABP N82 7622	-	ABP N82 W22
2007	2007	INTERNATIONAL/ NAVISTAR	7500	ABP N82 7622	-	ABP N82 W22
2007	2007	INTERNATIONAL/ NAVISTAR	7600	ABP N82 7622	-	ABP N82 W22
2007	2007	INTERNATIONAL/ NAVISTAR	7700	ABP N82 7622	-	ABP N82 W22
1987	1988	INTERNATIONAL/ NAVISTAR	8300	-	ABP N82 7114	ABP N82 WN13
2007	2007	INTERNATIONAL/ NAVISTAR	8500	ABP N82 7622	-	ABP N82 W22
2007	2007	INTERNATIONAL/ NAVISTAR	8600	ABP N82 7622	-	ABP N82 W22
1990	1992	INTERNATIONAL/ NAVISTAR	2000-SERIES	ABP N82 7614	-	ABP N82 W13
1993	1999	INTERNATIONAL/ NAVISTAR	2000-SERIES	ABP N82 7616	-	ABP N82 W16

HEAVY-DUTY APPLICATION GUIDE

START	END	MAKE	MODEL	UNIVERSAL	HEAVY-DUTY	WINTER
1989	1991	INTERNATIONAL/ NAVISTAR	400-900	ABP N82 7619	-	ABP N82 W18
1971	1973	INTERNATIONAL/ NAVISTAR	4200 & 4300	-	ABP N82 7116	ABP N82 WN16
2002	2003	INTERNATIONAL/ NAVISTAR	4200, 4300 & 4400	ABP N82 7622	-	ABP N82 W22
1982	1986	INTERNATIONAL/ NAVISTAR	4200, 4300 & 5000	-	ABP N82 7216	ABP N82 WN16
1974	1977	INTERNATIONAL/ NAVISTAR	4270 & 4370	-	ABP N82 7216	ABP N82 WN16
1990	1992	INTERNATIONAL/ NAVISTAR	4600, 4700, 4800 & 4900	ABP N82 7614	-	ABP N82 W13
1993	2001	INTERNATIONAL/ NAVISTAR	4600, 4700, 4800 & 4900	ABP N82 7616	-	ABP N82 W16
1987	1993	INTERNATIONAL/ NAVISTAR	5000-SERIES	-	ABP N82 7216	ABP N82 WN16
1994	1998	INTERNATIONAL/ NAVISTAR	5000-SERIES	ABP N82 7616	-	ABP N82 W16
1999	2000	INTERNATIONAL/ NAVISTAR	5000-SERIES	ABP N82 7618	-	ABP N82 W18
2007	2007	INTERNATIONAL/ NAVISTAR	5500I, 5600I, 5900I	ABP N82 7618	-	ABP N82 W18
1990	1991	INTERNATIONAL/ NAVISTAR	7000-SERIES	ABP N82 7614	-	ABP N82 W13
2002	2003	INTERNATIONAL/ NAVISTAR	7300, 7400, 7500 & 7600	ABP N82 7622	-	ABP N82 W22
2005	2007	INTERNATIONAL/ NAVISTAR	7300, 7400, 7500, 7600, 7700	ABP N82 7622	-	ABP N82 W22
1989	1992	INTERNATIONAL/ NAVISTAR	8100, 8200 & 8300	ABP N82 7614	-	ABP N82 W13
1993	2000	INTERNATIONAL/ NAVISTAR	8100, 8200 & 8300	ABP N82 7616	-	ABP N82 W16
2002	2003	INTERNATIONAL/ NAVISTAR	8500 & 8600	ABP N82 7622	-	ABP N82 W22
1994	1998	INTERNATIONAL/ NAVISTAR	9100, 9200, 9300, 9400 & 9900	ABP N82 7616	-	ABP N82 W16
1999	2003	INTERNATIONAL/ NAVISTAR	9100, 9200, 9400 & 9900	ABP N82 7622	-	ABP N82 W22
1984	1993	INTERNATIONAL/ NAVISTAR	9200, 9300 & 9400	-	ABP N82 7216	ABP N82 WN16
2007	2007	INTERNATIONAL/ NAVISTAR	9200I	ABP N82 7618	-	ABP N82 W18
2008	2009	INTERNATIONAL/ NAVISTAR	9200I	ABP N82 7621	-	ABP N82 W20
2007	2007	INTERNATIONAL/ NAVISTAR	9400I	ABP N82 7621	-	ABP N82 W20
2007	2010	INTERNATIONAL/ NAVISTAR	9900I, 9900IX	ABP N82 7622	-	ABP N82 W22
1970	1984	INTERNATIONAL/ NAVISTAR	CARGOSTAR	ABP N82 7616	-	ABP N82 W16



TRUCK

HEAVY-DUTY APPLICATION GUIDE

9

TRUCK

START	END	MAKE	MODEL	UNIVERSAL	HEAVY-DUTY	WINTER
2007	2007	INTERNATIONAL/ NAVISTAR	CF500	ABP N82 7620	-	ABP N82 W20
2005	2007	INTERNATIONAL/ NAVISTAR	CF500, CF600 D.S.	ABP N82 7621	-	ABP N82 W20
2005	2007	INTERNATIONAL/ NAVISTAR	CF500, CF600 P.S.	ABP N82 7620	-	ABP N82 W20
2008	2009	INTERNATIONAL/ NAVISTAR	CITYSTAR	ABP N82 7622	-	ABP N82 W22
1971	1972	INTERNATIONAL/ NAVISTAR	CO-190	-	ABP N82 7118	ABP N82 WN18
2005	2007	INTERNATIONAL/ NAVISTAR	CXT	ABP N82 7622	-	ABP N82 W22
2007	2007	INTERNATIONAL/ NAVISTAR	CXT	ABP N82 7622	-	ABP N82 W22
2008	2012	INTERNATIONAL/ NAVISTAR	DURASTAR	ABP N82 7622	-	ABP N82 W22
1967	1972	INTERNATIONAL/ NAVISTAR	FLEETSTAR A	ABP N82 7615	-	ABP N82 W15
1973	1978	INTERNATIONAL/ NAVISTAR	FLEETSTAR A	-	ABP N82 7215	ABP N82 WN15
1969	1974	INTERNATIONAL/ NAVISTAR	FLEETSTAR D	ABP N82 7612	-	-
1963	1971	INTERNATIONAL/ NAVISTAR	LOADSTAR	ABP N82 7616	-	ABP N82 W16
2009	2013	INTERNATIONAL/ NAVISTAR	LONESTAR	ABP N82 7622	-	ABP N82 W22
1967	1970	INTERNATIONAL/ NAVISTAR	METRO	-	ABP N82 7118	ABP N82 WN18
1987	1989	INTERNATIONAL/ NAVISTAR	METRO II (VAN)	-	ABP N82 7120	ABP N82 WN20
2005	2007	INTERNATIONAL/ NAVISTAR	MXT	ABP N82 7622	-	ABP N82 W22
2007	2007	INTERNATIONAL/ NAVISTAR	MXT	ABP N82 7622	-	ABP N82 W22
1974	1986	INTERNATIONAL/ NAVISTAR	PAYSTAR	-	ABP N82 7216	ABP N82 WN16
2007	2007	INTERNATIONAL/ NAVISTAR	PAYSTAR	ABP N82 7622	-	ABP N82 W22
2008	2012	INTERNATIONAL/ NAVISTAR	PAYSTAR	ABP N82 7622	-	ABP N82 W22
2007	2008	INTERNATIONAL/ NAVISTAR	PROSTAR	ABP N82 7622	-	ABP N82 W22
2007	2013	INTERNATIONAL/ NAVISTAR	PROSTAR	ABP N82 7622	-	ABP N82 W22
2005	2007	INTERNATIONAL/ NAVISTAR	RXT	ABP N82 7622	-	ABP N82 W22
2007	2007	INTERNATIONAL/ NAVISTAR	RXT	ABP N82 7622	-	ABP N82 W22
1973	1988	INTERNATIONAL/ NAVISTAR	S1600 THRU S2600	-	ABP N82 7114	ABP N82 WN13

HEAVY-DUTY APPLICATION GUIDE

START	END	MAKE	MODEL	UNIVERSAL	HEAVY-DUTY	WINTER
1989	1991	INTERNATIONAL/ NAVISTAR	S1600 THRU S8300	ABP N82 7614	-	ABP N82 W13
2010	2012	INTERNATIONAL/ NAVISTAR	TERRASTAR	ABP N82 7622	-	ABP N82 W22
1971	1993	INTERNATIONAL/ NAVISTAR	TRANSTAR	-	ABP N82 7216	ABP N82 WN16
2007	2007	INTERNATIONAL/ NAVISTAR	TRANSTAR	ABP N82 7622	-	ABP N82 W22
2008	2013	INTERNATIONAL/ NAVISTAR	TRANSTAR	ABP N82 7622	-	ABP N82 W22
1970	1977	INTERNATIONAL/ NAVISTAR	TRANSTAR II	-	ABP N82 7220	ABP N82 WN20
2007	2007	INTERNATIONAL/ NAVISTAR	WORKSTAR	ABP N82 7622	-	ABP N82 W22
2007	2013	INTERNATIONAL/ NAVISTAR	WORKSTAR	ABP N82 7622	-	ABP N82 W22
1997	2004	ISUZU	FRR, FSR, FTR & FVR	ABP N82 7622	-	ABP N82 W22
2005	2007	ISUZU	FTR, FVR, FXR	ABP N82 7622	-	ABP N82 W22
2007	2009	ISUZU	FTR,FVR, FXR-SERIES	ABP N82 7622	-	ABP N82 W22
1987	1996	ISUZU	FVR	ABP N82 7622	-	ABP N82 W22
2006	2007	ISUZU	HTR, HVR, HXR	ABP N82 7622	-	ABP N82 W22
2007	2007	ISUZU	HTR,HVR, HXR-SERIES	ABP N82 7622	-	ABP N82 W22
1986	1995	ISUZU	NPR	ABP N82 7619	-	ABP N82 W18
1996	2003	ISUZU	NPR	ABP N82 7620	-	ABP N82 W20
2007	2012	ISUZU	NPR	ABP N82 7620	-	ABP N82 W20
1987	1995	ISUZU	NPR & NRR-SERIES	ABP N82 7619	-	ABP N82 W18
1995	2007	ISUZU	NPR, NRR	ABP N82 7620	-	ABP N82 W20
1998	2003	ISUZU	NQR	ABP N82 7620	-	ABP N82 W20
2007	2012	ISUZU	NQR	ABP N82 7620	-	ABP N82 W20
2007	2012	ISUZU	NRR	ABP N82 7620	-	ABP N82 W20
1983	1991	IVECO	ALL MODELS	ABP N82 7618	-	ABP N82 W18
1965	1991	KENWORTH	C500, C500B	-	ABP N82 7114	ABP N82 WN13
1992	2000	KENWORTH	C500B	-	ABP N82 7113	ABP N82 WN13



TRUCK

HEAVY-DUTY APPLICATION GUIDE

9

TRUCK

START	END	MAKE	MODEL	UNIVERSAL	HEAVY-DUTY	WINTER
1963	1977	KENWORTH	K100	-	ABP N82 7218	ABP N82 WN18
1978	1996	KENWORTH	K100 & K100E	-	ABP N82 7220	ABP N82 WN20
1990	1993	KENWORTH	K130, K150 & K220	ABP N82 7619	-	ABP N82 W18
2007	2008	KENWORTH	K260	ABP N82 7624	-	ABP N82 W24
2007	2007	KENWORTH	K260	ABP N82 7624	-	ABP N82 W24
2000	2000	KENWORTH	K300	ABP N82 7621	-	ABP N82 W20
1993	1994	KENWORTH	K300, K330, & K333	-	ABP N82 7824	ABP N82 W24
2007	2008	KENWORTH	K360	ABP N82 7624	-	ABP N82 W24
1999	1999	KENWORTH	K37	-	ABP N82 7422	ABP N82 W22
1965	1979	KENWORTH	K90	-	ABP N82 7114	ABP N82 WN13
1984	1985	KENWORTH	L700	-	ABP N82 7120	ABP N82 WN20
1971	1976	KENWORTH	PD & HUSTLER	-	ABP N82 7118	ABP N82 WN18
2008	2009	KENWORTH	T170	ABP N82 7618	-	ABP N82 W18
1997	2005	KENWORTH	T2000	ABP N82 7619	-	ABP N82 W18
2006	2007	KENWORTH	T2000	ABP N82 7620	-	ABP N82 W20
2007	2008	KENWORTH	T2000	ABP N82 7620	-	ABP N82 W20
2007	2008	KENWORTH	T270	ABP N82 7618	-	ABP N82 W18
1995	2006	KENWORTH	T300	-	ABP N82 7218	ABP N82 WN18
2007	2008	KENWORTH	T300	ABP N82 7618	-	ABP N82 W18
2007	2007	KENWORTH	T300	ABP N82 7618	-	ABP N82 W18
2007	2008	KENWORTH	T370	ABP N82 7618	-	ABP N82 W18
2007	2012	KENWORTH	T370	ABP N82 7618	-	ABP N82 W18
1989	1994	KENWORTH	T400A & T400B	-	ABP N82 7113	ABP N82 WN13
2010	2012	KENWORTH	T440	ABP N82 7618	-	ABP N82 W18
1990	1995	KENWORTH	T450 & T450B	-	ABP N82 7113	ABP N82 WN13

HEAVY-DUTY APPLICATION GUIDE

START	END	MAKE	MODEL	UNIVERSAL	HEAVY-DUTY	WINTER
2010	2012	KENWORTH	T470	ABP N82 7618	-	ABP N82 W18
2007	2008	KENWORTH	T600	ABP N82 7618	-	ABP N82 W18
2007	2007	KENWORTH	T600 (ONE PIECE WINDSHIELD)	ABP N82 7618	-	ABP N82 W18
1985	1987	KENWORTH	T600A	-	ABP N82 7113	ABP N82 WN13
1988	2007	KENWORTH	T600A & T600B (1PC)	-	ABP N82 7218	ABP N82 WN18
1988	2006	KENWORTH	T600A & T600B (2PC)	-	ABP N82 7215	ABP N82 WN15
2007	2008	KENWORTH	T660	ABP N82 7618	-	ABP N82 W18
2007	2012	KENWORTH	T660	ABP N82 7618	-	ABP N82 W18
2010	2012	KENWORTH	T700	ABP N82 7620	-	ABP N82 W20
2007	2008	KENWORTH	T800	ABP N82 7618	-	ABP N82 W18
2009	2012	KENWORTH	T800	-	ABP N82 7215	ABP N82 WN16
1987	1994	KENWORTH	T800 & T800B	-	ABP N82 7113	ABP N82 WN13
2007	2008	KENWORTH	T800 (1PC)	ABP N82 7618	-	ABP N82 W18
1995	2003	KENWORTH	T800B (1PC)	-	ABP N82 7218	ABP N82 WN18
1995	2003	KENWORTH	T800B (2PC)	-	ABP N82 7113	ABP N82 WN13
1995	2003	KENWORTH	T800B (2PC)	-	ABP N82 7215	ABP N82 WN15
1965	1985	KENWORTH	W900	-	ABP N82 7114	ABP N82 WN13
2007	2012	KENWORTH	W900	ABP N82 7618	-	ABP N82 W18
2007	2008	KENWORTH	W900 (1PC)	ABP N82 7618	-	ABP N82 W18
1986	1994	KENWORTH	W900B	-	ABP N82 7113	ABP N82 WN13
1995	1998	KENWORTH	W900B & W900L (1PC)	-	ABP N82 7113	ABP N82 WN13
1999	2005	KENWORTH	W900B & W900L (1PC)	-	ABP N82 7218	ABP N82 WN18
1995	2008	KENWORTH	W900B & W900L (2PC CURVED)	-	ABP N82 7215	ABP N82 WN15
1995	2003	KENWORTH	W900B & W900L (2PC)	-	ABP N82 7113	ABP N82 WN13
1995	1997	KENWORTH	W900S	-	ABP N82 7113	ABP N82 WN13



TRUCK

HEAVY-DUTY APPLICATION GUIDE

9

TRUCK

START	END	MAKE	MODEL	UNIVERSAL	HEAVY-DUTY	WINTER
1989	2007	MACK	CH/CL-SERIES	ABP N82 7620	-	ABP N82 W20
2006	2008	MACK	CHN -SERIES	ABP N82 7620	-	ABP N82 W20
2007	2011	MACK	CHN-SERIES	ABP N82 7620	-	ABP N82 W20
2007	2008	MACK	CHU-SERIES	ABP N82 7620	-	ABP N82 W20
2007	2011	MACK	CHU-SERIES	ABP N82 7620	-	ABP N82 W20
2007	2007	MACK	CL-SERIES	ABP N82 7620	-	ABP N82 W20
1973	1985	MACK	CRUISELINER	-	ABP N82 7218	ABP N82 WN18
1980	1992	MACK	CS-SERIES	ABP N82 7620	-	ABP N82 W20
1993	2001	MACK	CS-SERIES	ABP N82 7624	-	ABP N82 W24
1999	2008	MACK	CX VISION-SERIES	ABP N82 7620	-	ABP N82 W20
1965	1993	MACK	DM, DMM & R-SERIES	-	ABP N82 7216	ABP N82 WN16
1994	2008	MACK	DM, DMM & R-SERIES	ABP N82 7618	-	ABP N82 W18
1962	1981	MACK	F-SERIES	-	ABP N82 7220	ABP N82 WN20
1990	1990	MACK	FDM 700	ABP N82 7614	-	ABP N82 W13
2002	2004	MACK	FREEDOM	ABP N82 7624	-	ABP N82 W24
2002	2008	MACK	GRANITE	ABP N82 7620	-	ABP N82 W20
2007	2012	MACK	GRANITE	ABP N82 7620	-	ABP N82 W20
2007	2008	MACK	GU-SERIES	ABP N82 7620	-	ABP N82 W20
1974	1978	MACK	HMM HALF CAB	-	ABP N82 7116	ABP N82 WN16
1998	2005	MACK	LE	ABP N82 7624	-	ABP N82 W24
1960	1975	MACK	M30X, M60X & M65X	-	ABP N82 7116	ABP N82 WN16
1998	1998	MACK	MAGNUM	ABP N82 7626	-	ABP N82 W26
1963	1978	MACK	MB-SERIES	-	ABP N82 7118	ABP N82 WN18
1980	1987	MACK	MC-SERIES	-	ABP N82 7122	ABP N82 WN22
1980	1991	MACK	MR-SERIES	-	ABP N82 7122	ABP N82 WN22

HEAVY-DUTY APPLICATION GUIDE

START	END	MAKE	MODEL	UNIVERSAL	HEAVY-DUTY	WINTER
1992	2004	MACK	MR-SERIES	-	ABP N82 7828	ABP N82 W28
1993	2003	MACK	MS-SERIES	ABP N82 7624	-	ABP N82 W24
1980	1992	MACK	MS-SERIES (MIDLINER)	ABP N82 7620	-	ABP N82 W20
2008	2012	MACK	PINNACLE	ABP N82 7620	-	ABP N82 W20
1998	1998	MACK	PREMIUM	ABP N82 7628	-	ABP N82 W28
2008	2012	MACK	TITAN	ABP N82 7620	-	ABP N82 W20
1970	1989	MACK	U-SERIES	-	ABP N82 7216	ABP N82 WN16
2007	2011	MACK	VISION	ABP N82 7620	-	ABP N82 W20
1984	1985	MAN	ALL	ABP N82 7620	-	ABP N82 W20
1968	1985	MARMON	ALL COE	-	ABP N82 7218	ABP N82 WN18
1974	1988	MARMON	ALL CONVENTIONAL	-	ABP N82 7114	ABP N82 WN13
1989	1997	MARMON	ALL CONVENTIONAL	ABP N82 7616	-	ABP N82 W16
1990	1990	MERCEDES	1319	ABP N82 7620	-	ABP N82 W20
1980	1991	MERCEDES	L-SERIES	ABP N82 7620	-	ABP N82 W20
1990	1992	MERCEDES	LPS1525	-	ABP N82 7724	ABP N82 W24
1984	1995	mitsubishi	FE, FG & FH-SERIES	ABP N82 7619	-	ABP N82 W18
1996	2003	mitsubishi	FE, FG & FH-SERIES	ABP N82 7621	-	ABP N82 W20
2007	2008	mitsubishi FUSO	FE	ABP N82 7621	-	ABP N82 W20
2009	2012	mitsubishi FUSO	FE	ABP N82 7620	-	ABP N82 W20
2007	2008	mitsubishi FUSO	FG	ABP N82 7621	-	ABP N82 W20
2007	2010	mitsubishi FUSO	FK	ABP N82 7626	-	ABP N82 W26
2007	2008	mitsubishi FUSO	FM	ABP N82 7626	-	ABP N82 W26
1976	1981	OSHKOSH	B-SERIES (HALF CAB)	-	ABP N82 7120	ABP N82 WN20
1965	1976	OSHKOSH	COUPE CAB	-	ABP N82 7113	ABP N82 WN13
1974	1991	OSHKOSH	F-SERIES	-	ABP N82 7114	ABP N82 WN13



TRUCK

HEAVY-DUTY APPLICATION GUIDE

9

TRUCK

START	END	MAKE	MODEL	UNIVERSAL	HEAVY-DUTY	WINTER
1990	1999	OSHKOSH	H & HB (FRONT)	-	ABP N82 7114	ABP N82 WN13
1990	1999	OSHKOSH	H & HB (LEFT & RIGHT DOORS)	-	ABP N82 7112	-
1970	1999	OSHKOSH	P-SERIES (FRONT)	-	ABP N82 7114	ABP N82 WN13
1970	1999	OSHKOSH	P-SERIES (SIDES)	-	ABP N82 7112	-
1976	1978	OSHKOSH	P-15 (FIRE TRUCK)	-	ABP N82 7122	ABP N82 WN22
1983	1998	OSHKOSH	S-SERIES	-	ABP N82 7220	ABP N82 WN20
1972	1976	OTTAWA	30, 50 & 60	-	ABP N82 7122	ABP N82 WN22
1977	1979	OTTAWA	30, 50, 60 & 70	-	ABP N82 7116	ABP N82 WN16
1993	1999	OTTAWA	COMMANDO 30, 50 & 60	-	ABP N82 7728	ABP N82 W28
1980	1985	OTTAWA	COMMERCIAL UNITS	-	ABP N82 7122	ABP N82 WN22
1980	1985	OTTAWA	OFF-HIGHWAY UNITS	-	ABP N82 7122	ABP N82 WN22
1987	1992	OTTAWA	ROUGE	-	ABP N82 7122	ABP N82 WN22
2008	2012	PETERBILT	210	ABP N82 7624	-	ABP N82 W24
2008	2012	PETERBILT	220	ABP N82 7624	-	ABP N82 W24
2000	2001	PETERBILT	270	-	ABP N82 7220	ABP N82 WN20
2007	2007	PETERBILT	320	ABP N82 7620	-	ABP N82 W20
1995	2003	PETERBILT	330	ABP N82 7618	-	ABP N82 W18
1981	1998	PETERBILT	362	-	ABP N82 7120	ABP N82 WN20
1999	1999	PETERBILT	362	-	ABP N82 7222	ABP N82 WN22
1989	1992	PETERBILT	372	ABP N82 7620	-	ABP N82 W20
1996	1999	PETERBILT	377	ABP N82 7615	-	ABP N82 W15
2006	2008	PETERBILT	387	ABP N82 7620	-	ABP N82 W20
2007	2011	PETERBILT	387	ABP N82 7620	-	ABP N82 W20
2011	2012	PETERBILT	587	ABP N82 7620	-	ABP N82 W20
1989	1989	PETERBILT	13-210 MID RANGER	ABP N82 7618	-	ABP N82 W18

HEAVY-DUTY APPLICATION GUIDE

START	END	MAKE	MODEL	UNIVERSAL	HEAVY-DUTY	WINTER
1990	1997	PETERBILT	200-SERIES MID RANGER	-	ABP N82 7824	ABP N82 W24
1987	1991	PETERBILT	210, 224, 265 & 227	ABP N82 7620	-	ABP N82 W20
1978	1980	PETERBILT	282, 352 & 352H	-	ABP N82 7216	ABP N82 WN16
1980	2004	PETERBILT	310 & 320	-	ABP N82 7120	ABP N82 WN20
1988	1999	PETERBILT	330, 357, 375 & 377	ABP N82 7618	-	ABP N82 W18
1988	1999	PETERBILT	379, 379 & 385	ABP N82 7618	-	ABP N82 W18
2011	2012	PETERBILT	ALL CONVENTIONAL (EXCEPT 387, 587)	ABP N82 7616	-	ABP N82 W16
1996	1996	PETERBILT	ALL CONVENTIONAL (377)	ABP N82 7618	-	ABP N82 W18
1997	1999	PETERBILT	ALL CONVENTIONAL (EXCEPT 377, 385)	ABP N82 7618	-	ABP N82 W18
2000	2008	PETERBILT	ALL CONVENTIONAL (EXCEPT 387)	ABP N82 7618	-	ABP N82 W18
2007	2010	PETERBILT	ALL CONVENTIONAL (EXCEPT 387)	ABP N82 7618	-	ABP N82 W18
1964	1972	PETERBILT	ALL CONVENTIONAL CABS	-	ABP N82 7113	ABP N82 WN13
1973	1986	PETERBILT	ALL CONVENTIONAL CABS	-	ABP N82 7116	ABP N82 WN16
1987	1995	PETERBILT	ALL CONVENTIONAL CABS	ABP N82 7618	-	ABP N82 W18
1969	1980	PETERBILT	ALL OTHER COE	-	ABP N82 7117	ABP N82 WN16
1986	1992	SCANIA	112 & 113	ABP N82 7624	-	ABP N82 W24
1996	1998	SISU	MAGNUM	-	ABP N82 7724	ABP N82 W24
2007	2009	STERLING	360	ABP N82 7621	-	ABP N82 W20
2007	2007	STERLING	360 D.S.	ABP N82 7621	-	ABP N82 W20
2007	2007	STERLING	360 P.S.	ABP N82 7620	-	ABP N82 W20
1998	1999	STERLING	9501, 9511, 9513 & 9522	ABP N82 7620	-	ABP N82 W20
1998	2007	STERLING	A/AT 9513 & 9522	ABP N82 7620	-	ABP N82 W20
2007	2009	STERLING	A/AT-SERIES	ABP N82 7620	-	ABP N82 W20



TRUCK

HEAVY-DUTY APPLICATION GUIDE

9

TRUCK

START	END	MAKE	MODEL	UNIVERSAL	HEAVY-DUTY	WINTER
2000	2007	STERLING	ACTERRA	ABP N82 7620	-	ABP N82 W20
2007	2009	STERLING	ACTERRA	ABP N82 7620	-	ABP N82 W20
2008	2009	STERLING	BULLET	ABP N82 7624	-	ABP N82 W24
2006	2006	STERLING	CONDOR	-	ABP N82 7828	ABP N82 W28
1998	2007	STERLING	L/LT 7501, 8511 & 8513	ABP N82 7620	-	ABP N82 W20
2007	2009	STERLING	L/LT-SERIES	ABP N82 7620	-	ABP N82 W20
1998	2003	STERLING	SC7000, 8000 & CARGO	-	ABP N82 7726	ABP N82 W26
1998	2004	STERLING	SC8000 (CARGO)	-	ABP N82 7826	ABP N82 W26
1998	2003	STERLING	SILVER STAR	ABP N82 7620	-	ABP N82 W20
1994	1994	SUPREME CORP.	STEP VAN	ABP N82 7618	-	ABP N82 W18
2005	2007	UD/NISSAN TRUCKS	1300	ABP N82 7620	-	ABP N82 W20
2007	2007	UD/NISSAN TRUCKS	1300	ABP N82 7620	-	ABP N82 W20
1999	1999	UD/NISSAN TRUCKS	1400	ABP N82 7620	-	ABP N82 W20
2007	2009	UD/NISSAN TRUCKS	1400	ABP N82 7620	-	ABP N82 W20
1995	2000	UD/NISSAN TRUCKS	1800	-	ABP N82 7726	ABP N82 W26
2001	2007	UD/NISSAN TRUCKS	1800	ABP N82 7626	-	ABP N82 W26
2007	2009	UD/NISSAN TRUCKS	1800	ABP N82 7626	-	ABP N82 W26
1998	2006	UD/NISSAN TRUCKS	2000	-	ABP N82 7726	ABP N82 W26
2007	2007	UD/NISSAN TRUCKS	2000	ABP N82 7626	-	ABP N82 W26
2007	2009	UD/NISSAN TRUCKS	2000	ABP N82 7626	-	ABP N82 W26
2012	2012	UD/NISSAN TRUCKS	2000	ABP N82 7622	-	ABP N82 W22
1995	2006	UD/NISSAN TRUCKS	2300	-	ABP N82 7726	ABP N82 W26
2007	2007	UD/NISSAN TRUCKS	2300	ABP N82 7626	-	ABP N82 W26
2007	2009	UD/NISSAN TRUCKS	2300	ABP N82 7626	-	ABP N82 W26
2012	2012	UD/NISSAN TRUCKS	2300	ABP N82 7622	-	ABP N82 W22

HEAVY-DUTY APPLICATION GUIDE

START	END	MAKE	MODEL	UNIVERSAL	HEAVY-DUTY	WINTER
1995	2000	UD/NISSAN TRUCKS	2600	-	ABP N82 7728	ABP N82 W28
2001	2007	UD/NISSAN TRUCKS	2600	ABP N82 7626	-	ABP N82 W26
2007	2009	UD/NISSAN TRUCKS	2600	ABP N82 7626	-	ABP N82 W26
2012	2012	UD/NISSAN TRUCKS	2600	ABP N82 7622	-	ABP N82 W22
1994	1994	UD/NISSAN TRUCKS	3000	ABP N82 7619	-	ABP N82 W18
1995	2000	UD/NISSAN TRUCKS	3000	-	ABP N82 7726	ABP N82 W26
1999	2000	UD/NISSAN TRUCKS	3300	-	ABP N82 7726	ABP N82 W26
2001	2007	UD/NISSAN TRUCKS	3300	ABP N82 7626	-	ABP N82 W26
2007	2009	UD/NISSAN TRUCKS	3300	ABP N82 7626	-	ABP N82 W26
1987	1988	UD/NISSAN TRUCKS	CLA 83D & CMA83E	ABP N82 7619	-	ABP N82 W18
1986	1987	UD/NISSAN TRUCKS	CPB12H, CRC12H & CPC1ZE	ABP N82 7618	-	ABP N82 W18
1988	1991	UD/NISSAN TRUCKS	UD 1100	ABP N82 7618	-	ABP N82 W18
1994	1998	UD/NISSAN TRUCKS	UD 1400	ABP N82 7620	-	ABP N82 W20
1988	1993	UD/NISSAN TRUCKS	UD 1800-UD 3300	ABP N82 7618	-	ABP N82 W18
1994	1994	UD/NISSAN TRUCKS	UD 1800-UD 3300	ABP N82 7619	-	ABP N82 W18
1994	1994	UNION CITY BODY COMPANY	STEP VAN	ABP N82 7618	-	ABP N82 W18
2003	2003	UNION CITY BODY COMPANY	STEP VAN	ABP N82 7618	-	ABP N82 W18
1971	1978	VOLVO/WHITE	6000	-	ABP N82 7118	ABP N82 WN18
1960	1973	VOLVO/WHITE	1500 & 7400	-	ABP N82 7118	ABP N82 WN18
1960	1973	VOLVO/WHITE	1500 (VACUUM)	ABP N82 7614	-	ABP N82 W13
1967	1977	VOLVO/WHITE	4000 & 9000 (SADDLE)	-	ABP N82 7216	ABP N82 WN16
1965	1977	VOLVO/WHITE	4000 & 9000 (STRAIGHT)	ABP N82 7616	-	ABP N82 W16
1988	2000	VOLVO/WHITE	ACL AUTOCAR-SERIES	ABP N82 7620	-	ABP N82 W20
1984	1996	VOLVO/WHITE	ALL WHITE CONVENTIONAL	ABP N82 7620	-	ABP N82 W20
1986	1990	VOLVO/WHITE	ALL WHITE CONVENTIONAL	-	ABP N82 7220	ABP N82 WN20



TRUCK

HEAVY-DUTY APPLICATION GUIDE

9

TRUCK

START	END	MAKE	MODEL	UNIVERSAL	HEAVY-DUTY	WINTER
1976	1978	VOLVO/WHITE	CONVENTIONAL	-	ABP N82 7216	ABP N82 WN16
1979	1980	VOLVO/WHITE	F86	ABP N82 7618	-	ABP N82 W18
1979	1997	VOLVO/WHITE	FE-SERIES	-	ABP N82 7724	ABP N82 W24
1979	1987	VOLVO/WHITE	HI-CAB	-	ABP N82 7218	ABP N82 WN18
1980	1987	VOLVO/WHITE	N-SERIES	ABP N82 7616	-	ABP N82 W16
1973	1975	VOLVO/WHITE	POWERLINER	-	ABP N82 7220	ABP N82 WN20
1967	1977	VOLVO/WHITE	ROAD BOSS (SADDLE)	-	ABP N82 7216	ABP N82 WN16
1967	1977	VOLVO/WHITE	ROAD BOSS (STRAIGHT)	ABP N82 7616	-	ABP N82 W16
1975	1985	VOLVO/WHITE	ROAD BOSS 2	-	ABP N82 7220	ABP N82 WN20
1971	1975	VOLVO/WHITE	ROAD COMMANDER	-	ABP N82 7218	ABP N82 WN18
1976	1983	VOLVO/WHITE	ROAD COMMANDER 2	-	ABP N82 7220	ABP N82 WN20
1974	1977	VOLVO/WHITE	ROAD XPEDITOR	-	ABP N82 7218	ABP N82 WN18
1978	1983	VOLVO/WHITE	ROAD XPEDITOR 2	-	ABP N82 7220	ABP N82 WN20
1967	1971	VOLVO/WHITE	TREND	-	ABP N82 7120	ABP N82 WN20
2001	2008	VOLVO/WHITE	VHD	ABP N82 7622	-	ABP N82 W22
2007	2012	VOLVO/WHITE	VHD	ABP N82 7622	-	ABP N82 W22
1997	2008	VOLVO/WHITE	VN-SERIES	ABP N82 7622	-	ABP N82 W22
2007	2012	VOLVO/WHITE	VN-SERIES	ABP N82 7622	-	ABP N82 W22
2006	2006	VOLVO/WHITE	VT	ABP N82 7622	-	ABP N82 W22
2007	2010	VOLVO/WHITE	VT	ABP N82 7622	-	ABP N82 W22
1984	2001	VOLVO/WHITE	WA, WC, WG, WH & WI-SERIES	ABP N82 7620	-	ABP N82 W20
1967	1977	VOLVO/WHITE	WESTERN STAR (SADDLE)	-	ABP N82 7216	ABP N82 WN16
1979	1984	VOLVO/WHITE	WESTERN STAR (SADDLE)	-	ABP N82 7218	ABP N82 WN18
1967	1977	VOLVO/WHITE	WESTERN STAR (STRAIGHT)	ABP N82 7616	-	ABP N82 W16
1984	1995	VOLVO/WHITE	WH-SERIES	-	ABP N82 7220	ABP N82 WN20

HEAVY-DUTY APPLICATION GUIDE

START	END	MAKE	MODEL	UNIVERSAL	HEAVY-DUTY	WINTER
1994	1998	VOLVO/WHITE	XPEDITOR (WX)	-	ABP N82 7220	ABP N82 WN20
1980	1980	WALTER	B-SERIES	-	ABP N82 7120	ABP N82 WN20
1980	1980	WALTER	U-SERIES	-	ABP N82 7117	ABP N82 WN16
1980	1980	WALTER	Z-SERIES	-	ABP N82 7120	ABP N82 WN20
2000	2000	WESTERN STAR	3700-SERIES	ABP N82 7622	-	ABP N82 W22
1996	2003	WESTERN STAR	4800 THRU 6900	ABP N82 7620	-	ABP N82 W20
1979	1987	WESTERN STAR	ALL COE	-	ABP N82 7220	ABP N82 WN20
2007	2012	WESTERN STAR	ALL CONVENTIONAL	ABP N82 7620	-	ABP N82 W20
1981	1984	WESTERN STAR	ALL CONVENTIONAL CABS	-	ABP N82 7218	ABP N82 WN18
1990	1995	WESTERN STAR	ALL CONVENTIONAL CABS	ABP N82 7618	-	ABP N82 W18
1996	1999	WESTERN STAR	ALL CONVENTIONAL CABS	ABP N82 7620	-	ABP N82 W20
2000	2008	WESTERN STAR	ALL CONVENTIONAL CABS	ABP N82 7620	-	ABP N82 W20



TRUCK

HEAVY-DUTY APPLICATION GUIDE

BUS

START	END	MAKE	MODEL	UNIVERSAL	HEAVY-DUTY	WINTER
2003	2003	DAIMLER CHRYSLER	SLF 200	-	ABP N82 7728	ABP N82 W28
1997	1997	DINA	VIAGGIO 1000	-	ABP N82 7728	ABP N82 W28
1997	1997	EL DORADO	AEROLITE	ABP N82 7618	-	ABP N82 W18
2003	2003	EL DORADO	AXECC	-	ABP N82 7724	ABP N82 W24
1997	2003	EL DORADO	E-Z RIDER	-	ABP N82 7824	ABP N82 W24
2006	2006	EL DORADO	E-Z RIDER II	-	ABP N82 7732	-
1997	2003	EL DORADO	MST	-	ABP N82 7724	ABP N82 W24
1997	2003	EL DORADO	TRANSMARK R. E.	-	ABP N82 7724	ABP N82 W24
1993	1994	ELF	200-SERIES	-	ABP N82 7222	ABP N82 WN22
-	-	ETI (AAI & SKODA)	ELECTRIC TROLLY BUS (DS)	-	ABP N82 7724	ABP N82 W24
-	-	ETI (AAI & SKODA)	ELECTRIC TROLLY BUS (PS)	-	ABP N82 7826	ABP N82 W26
1978	1999	FLEXIBLE BUS	96 & 102 COACH	-	ABP N82 7826	ABP N82 W26
-	-	FLYER INDUSTRIES	CITY BUS "31"	-	ABP N82 7826	ABP N82 W26
-	-	FLYER INDUSTRIES	D900	-	ABP N82 7826	ABP N82 W26
-	-	FLYER INDUSTRIES	D901	-	ABP N82 7826	ABP N82 W26
-	-	GILLIG BUS	GERMAN COACH 32	-	ABP N82 7726	ABP N82 W26
1997	2003	GILLIG BUS	LOW FLOOR	-	ABP N82 7222	ABP N82 WN22
1997	2002	GILLIG BUS	PHANTOM COACH	-	ABP N82 7222	ABP N82 WN22
2003	2003	GILLIG BUS	PHANTOM COACH	-	ABP N82 7724	ABP N82 W24
2005	2005	GLAVAL BUS	LF72 WORKHOURSE	-	ABP N82 7828	ABP N82 W28
-	-	GMC	96 & 102 COACH	-	ABP N82 7218	ABP N82 WN18
-	-	GMC	RTS COACH	-	ABP N82 7826	ABP N82 W26
1997	2001	GOSHEN COACH	SENTINAL	-	ABP N82 7724	ABP N82 W24
1978	1994	GRUMMAN	870 COACH	-	ABP N82 7826	ABP N82 W26
2007	2007	IC CORP	FC	-	ABP N82 7728	ABP N82 W28
2007	2007	IC CORP	HC	ABP N82 7622	-	ABP N82 W22
2007	2007	IC CORP	LC	ABP N82 7622	-	ABP N82 W22
1993	1999	IKARUS	406	-	ABP N82 7826	ABP N82 W26
1994	2001	MCI	A3	-	ABP N82 7826	ABP N82 W26
2003	2003	MCI	AMERICAN CLASSIC	-	ABP N82 7828	ABP N82 W28

HEAVY-DUTY APPLICATION GUIDE

START	END	MAKE	MODEL	UNIVERSAL	HEAVY-DUTY	WINTER
2003	2003	MCI	COMMUTER COACH	-	ABP N82 7828	ABP N82 W28
1994	2001	MCI	DL3	-	ABP N82 7726	ABP N82 W26
2003	2003	MCI	HYBRID	-	ABP N82 7828	ABP N82 W28
2003	2003	MCI	ISTV	-	ABP N82 7828	ABP N82 W28
2003	2003	MCI	UNIVERSITY TRANSPORTATION COACH	-	ABP N82 7828	ABP N82 W28
2006	2006	MILLENNIUM TRANSIT SERVICES	RTS	-	ABP N82 7826	ABP N82 W26
2000	2003	NABI	ALL MODELS	-	ABP N82 7732	-
1982	1999	NEOPLAN USA	96 & 102 COACH	-	ABP N82 7826	ABP N82 W26
1988	2002	NEOPLAN USA	AN-SERIES	-	ABP N82 7826	ABP N82 W26
2003	2003	NEOPLAN USA	AN340 & AN345	-	ABP N82 7732	-
2003	2003	NEOPLAN USA	AN435, AN440 & AN445	-	ABP N82 7728	ABP N82 W28
2003	2003	NEOPLAN USA	AN460	-	ABP N82 7726	ABP N82 W26
1996	1996	NEOPLAN USA	NEOPLAN	-	ABP N82 7728	ABP N82 W28
2003	2003	NEW FLYER	C30LF, C35LF, C40LF, D30LF, DE40LF & DE60LF	-	ABP N82 7826	ABP N82 W26
1986	2003	NEW FLYER	D35LF, D40LF & D60LF	-	ABP N82 7826	ABP N82 W26
2003	2003	NEW FLYER	D40I INVERNO	-	ABP N82 7732	-
-	-	NEW FLYER	D900 & D901	-	ABP N82 7826	ABP N82 W26
2005	2005	NEW FLYER INDUSTRIES	D40LF	-	ABP N82 7732	-
1993	1994	NEW GOSHEN COACH	SENTRY	-	ABP N82 7826	ABP N82 W26
2003	2003	NOVA BUS	NOVA LFS	-	ABP N82 7732	-
1997	1997	NOVA BUS	RTS	-	ABP N82 7826	ABP N82 W26
1986	1992	ORION	MODEL 1-5	-	ABP N82 7220	ABP N82 WN20
1993	2003	ORION	MODEL 1-7	-	ABP N82 7826	ABP N82 W26
2003	2003	PREVOST	H-SERIES	-	ABP N82 7828	ABP N82 W28
2003	2003	PREVOST	LE MIRAGE	-	ABP N82 7828	ABP N82 W28
2007	2007	REXHALL	CA6100	-	ABP N82 7724	ABP N82 W24
1976	1978	ROHR CORP.	BART	-	ABP N82 7220	ABP N82 WN20
1974	1978	ROHR CORP.	WMTA	-	ABP N82 7222	ABP N82 WN22



BUS

HEAVY-DUTY APPLICATION GUIDE

START	END	MAKE	MODEL	UNIVERSAL	HEAVY-DUTY	WINTER
2003	2003	SETRA	S215 & S217	-	ABP N82 7828	ABP N82 W28
1997	1997	THOMAS	CITILINER	-	ABP N82 7220	ABP N82 WN20
1997	1997	THOMAS	TL 960	-	ABP N82 7728	ABP N82 W28
1987	1999	TMC	RTS COACH	-	ABP N82 7726	ABP N82 W26
1995	1997	AMERICAN TRANSPORT	AMTRAN RE	-	ABP N82 7728	ABP N82 W28
1998	2001	AMERICAN TRANSPORT	AMTRAN RE	ABP N82 7624	-	ABP N82 W24
1992	1997	AMERICAN TRANSPORT	CONVENTIONAL CHASSIS	ABP N82 7616	-	ABP N82 W16
1998	2001	AMERICAN TRANSPORT	CONVENTIONAL CHASSIS	ABP N82 7622	-	ABP N82 W22
1996	2001	AMERICAN TRANSPORT	GENESIS	-	ABP N82 7724	ABP N82 W24
2007	2010	BLUE BIRD	ALL AMERICAN	ABP N82 7622	-	ABP N82 W22
1962	2003	BLUE BIRD	ALL AMERICAN (CURVED)	-	ABP N82 7220	ABP N82 WN20
1990	2003	BLUE BIRD	ALL AMERICAN (CURVED)	-	ABP N82 7220	ABP N82 WN20
1962	2003	BLUE BIRD	ALL AMERICAN (FLAT)	-	ABP N82 7218	ABP N82 WN18
1970	1989	BLUE BIRD	ALL AMERICAN (FLAT)	-	ABP N82 7220	ABP N82 WN20
2006	2006	BLUE BIRD	ALL AMERICAN (FLAT)	-	ABP N82 7422	ABP N82 W22
1962	1974	BLUE BIRD	CONVENTIONAL CHASSIS	-	ABP N82 7116	ABP N82 WN16
1975	2002	BLUE BIRD	CONVENTIONAL CHASSIS	-	ABP N82 7218	ABP N82 WN18
1975	2003	BLUE BIRD	CONVENTIONAL CHASSIS (FLAT)	-	ABP N82 7118	ABP N82 WN18
1975	2003	BLUE BIRD	CONVENTIONAL CHASSIS (CURVED)	-	ABP N82 7218	ABP N82 WN18
1997	1998	BLUE BIRD	TC 1000 (CURVED)	-	ABP N82 7724	ABP N82 W24
1997	1998	BLUE BIRD	TC 1000 (FLAT)	-	ABP N82 7422	ABP N82 W22
1987	1990	BLUE BIRD	TC 2000	-	ABP N82 7218	ABP N82 WN18
1990	1992	BLUE BIRD	TC 2000	-	ABP N82 7220	ABP N82 WN20
	1990	BLUE BIRD	TC 2000	-	ABP N82 7218	ABP N82 WN18
1993	2002	BLUE BIRD	TC 2000 (CURVED)	-	ABP N82 7724	ABP N82 W24
1993	2002	BLUE BIRD	TC 2000 (FLAT)	-	ABP N82 7724	ABP N82 W24
2003	2003	BLUE BIRD	VISION	-	ABP N82 7218	ABP N82 WN18
2007	2010	BLUE BIRD	VISION	ABP N82 7618	-	ABP N82 W18
2008	2008	BLUE BIRD	VISION	ABP N82 7618	-	ABP N82 W18

HEAVY-DUTY APPLICATION GUIDE

START	END	MAKE	MODEL	UNIVERSAL	HEAVY-DUTY	WINTER
2004	2007	BLUE BIRD	VISION (CURVED)	-	ABP N82 7218	ABP N82 WN18
2004	2007	BLUE BIRD	VISION (FLAT)	-	ABP N82 7118	ABP N82 WN18
1967	1986	CARPENTER	CONVENTIONAL CHASSIS	ABP N82 7616	-	ABP N82 W16
1987	1992	CARPENTER	CONVENTIONAL CHASSIS	-	ABP N82 7216	ABP N82 WN16
1996	2003	CARPENTER	CROWN CONVENTIONAL CHASSIS	ABP N82 7618	-	ABP N82 W18
1996	2003	CARPENTER	CROWN FE	-	ABP N82 7724	ABP N82 W24
1965	1981	CARPENTER	TRUCK TYPE CHASSIS	ABP N82 7616	-	ABP N82 W16
1987	1992	CORBIEL	CONVENTIONAL CHASSIS	-	ABP N82 7118	ABP N82 WN18
1960	1981	CROWN COACH	CONVENTIONAL CHASSIS	-	ABP N82 7120	ABP N82 WN20
1961	1982	GILLIG BUS	CONVENTIONAL CHASSIS	-	ABP N82 7118	ABP N82 WN18
2007	2011	IC BUS	BE200	ABP N82 7624	-	ABP N82 W24
2007	2011	IC BUS	CE300	ABP N82 7624	-	ABP N82 W24
2007	2007	IC BUS	FE	ABP N82 7624	-	ABP N82 W24
2007	2008	IC BUS	RE300	ABP N82 7624	-	ABP N82 W24
2006	2007	INTERNATIONAL	BE200	ABP N82 7624	-	ABP N82 W24
2002	2003	INTERNATIONAL	CE	ABP N82 7622	-	ABP N82 W22
2002	2006	INTERNATIONAL	CE200	ABP N82 7622	-	ABP N82 W22
2005	2007	INTERNATIONAL	CE300	ABP N82 7624	-	ABP N82 W24
2002	2003	INTERNATIONAL	FE & RE	ABP N82 7624	-	ABP N82 W24
2007	2008	INTERNATIONAL	RE300	ABP N82 7624	-	ABP N82 W24
1960	1982	SUPERIOR COACH	CONVENTIONAL CHASSIS	-	ABP N82 7218	ABP N82 WN18
1968	1982	SUPERIOR COACH	TRUCK TYPE CHASSIS	-	ABP N82 7218	ABP N82 WN18
1960	1971	THOMAS	CONVENTIONAL CHASSIS	-	ABP N82 7114	ABP N82 WN13
1972	2003	THOMAS	CONVENTIONAL CHASSIS	-	ABP N82 7118	ABP N82 WN18
2007	2007	THOMAS	CONVENTIONAL CHASSIS	-	ABP N82 7220	ABP N82 WN20
2007	2007	THOMAS	CONVENTIONAL CHASSIS	ABP N82 7620	-	ABP N82 W20
1974	1980	THOMAS	SAF-T-LINER	-	ABP N82 7220	ABP N82 WN20
1983	1983	THOMAS	SAF-T-LINER	-	ABP N82 7218	ABP N82 WN18



BUS

HEAVY-DUTY APPLICATION GUIDE

START	END	MAKE	MODEL	UNIVERSAL	HEAVY-DUTY	WINTER
1992	2003	THOMAS	SAF-T-LINER	-	ABP N82 7728	ABP N82 W28
1992	2007	THOMAS	SAF-T-LINER	-	ABP N82 7728	ABP N82 W28
2007	2007	THOMAS	SAF-T-LINER	ABP N82 7618	-	ABP N82 W18
2007	2012	THOMAS	SAF-T-LINER C2	ABP N82 7628	-	ABP N82 W28
2005	2008	THOMAS	SAF-T-LINER C2 D.S.	ABP N82 7628	-	ABP N82 W28
2005	2008	THOMAS	SAF-T-LINER C2 P.S.	ABP N82 7624	-	ABP N82 W24
1972	1990	THOMAS	TRUCK TYPE CHASSIS	-	ABP N82 7218	ABP N82 WN18
1980	1980	THOMAS	TRUCK TYPE CHASSIS	-	ABP N82 7220	ABP N82 WN20
1972	1981	WARD	CONVENTIONAL CHASSIS	-	ABP N82 7116	ABP N82 WN16
1982	1991	WARD	CONVENTIONAL CHASSIS	ABP N82 7616	-	ABP N82 W16
1971	1981	WARD	TRUCK TYPE CHASSIS	-	ABP N82 7216	ABP N82 WN16
1982	1982	WARD	TRUCK TYPE CHASSIS	ABP N82 7616	-	ABP N82 W16
1969	1990	WAYNE WORKS	CONVENTIONAL CHASSIS	-	ABP N82 7118	ABP N82 WN18
1990	1990	CHEVROLET	AEROMASTER	-	ABP N82 7122	ABP N82 WN22
1978	1987	CHEVROLET	GRUMMAN	-	ABP N82 7120	ABP N82 WN20
1993	1999	CHEVROLET	GRUMMAN	ABP N82 7620	-	ABP N82 W20
1970	1990	CHEVROLET	P-SERIES	ABP N82 7616	-	ABP N82 W16
1991	2002	CHEVROLET	P-SERIES	ABP N82 7618	-	ABP N82 W18
2003	2006	DODGE	SPRINTER D.S.	ABP N82 7624	-	ABP N82 W24
2007	2007	DODGE	SPRINTER D.S.	ABP N82 7626	-	ABP N82 W26
2003	2006	DODGE	SPRINTER P.S.	ABP N82 7622	-	ABP N82 W22
2007	2007	DODGE	SPRINTER P.S.	ABP N82 7624	-	ABP N82 W24
1996	1998	FREIGHTLINER	MT	ABP N82 7618	-	ABP N82 W18
2001	2003	FREIGHTLINER	SPRINTER D.S.	ABP N82 7624	-	ABP N82 W24
2001	2003	FREIGHTLINER	SPRINTER P.S.	ABP N82 7622	-	ABP N82 W22
1978	1987	GMC	GRUMMAN	-	ABP N82 7120	ABP N82 WN20
1993	1999	GMC	GRUMMAN	ABP N82 7620	-	ABP N82 W20
1970	1990	GMC	P-SERIES	ABP N82 7616	-	ABP N82 W16
1991	2002	GMC	P-SERIES	ABP N82 7618	-	ABP N82 W18
1987	1995	GRUMMAN	LLV POSTAL TRUCK	-	ABP N82 7220	ABP N82 WN20

HEAVY-DUTY APPLICATION GUIDE

START	END	MAKE	MODEL	UNIVERSAL	HEAVY-DUTY	WINTER
1978	1987	GRUMMAN	STEP VAN	-	ABP N82 7120	ABP N82 WN20
1996	1996	GRUMMAN	STEP VAN	-	ABP N82 7824	ABP N82 W24
1971	1973	INTERNATIONAL/ NAVISTAR	TRANSTAR 4200 & 4300	ABP N82 7616	-	ABP N82 W16
1996	1996	INTERNATIONAL/ NAVISTAR	WALK IN	-	ABP N82 7724	ABP N82 W24
1990	1994	UTILMASTER	AEROMATE	-	ABP N82 7122	ABP N82 WN22
1999	1999	UTILMASTER	STEP VAN	ABP N82 7624	-	ABP N82 W24
2000	2002	WORKHORSE	P-SERIES	ABP N82 7618	-	ABP N82 W18
-	-	AM GENERAL	96 & 102 COACH	-	ABP N82 7218	ABP N82 WN18
2003	2003	AVS	AVS22, AVS30, AVS35 & AVS40	-	ABP N82 7732	-
-	-	BLUE BIRD	CITY BIRD	-	ABP N82 7218	ABP N82 WN18
2003	2003	BLUE BIRD	COMMUTER COACH	-	ABP N82 7724	ABP N82 W24
2005	2006	BLUE BIRD	EXPRESS	-	ABP N82 7828	ABP N82 W28
1993	1999	BLUE BIRD	Q-BUS & CS-SERIES	-	ABP N82 7724	ABP N82 W24
1997	1997	BLUE BIRD	SHUTTLE	-	ABP N82 7724	ABP N82 W24
2003	2003	BLUE BIRD	ULTRA LF	-	ABP N82 7828	ABP N82 W28
2005	2006	BLUE BIRD	ULTRA LF	-	ABP N82 7732	-
2003	2003	BLUE BIRD	XCEL 102	-	ABP N82 7826	ABP N82 W26
-	-	BREDA	CLEVELAND GCTRA	-	ABP N82 7826	ABP N82 W26
1996	1999	CARPENTER	CROWN	-	ABP N82 7724	ABP N82 W24
1996	1999	CARPENTER	CROWN	-	ABP N82 7824	ABP N82 W24
1997	1997	CHAMPION	CONTENDER	-	ABP N82 7828	ABP N82 W28
1993	2003	CHAMPION	CTS	-	ABP N82 7724	ABP N82 W24
1997	1997	CHAMPION	SOLO	-	ABP N82 7828	ABP N82 W28
2003	2003	CHAMPION	TROLLEY	-	ABP N82 7824	ABP N82 W24
1993	2003	CHANCE COACH	AH-28	-	ABP N82 7220	ABP N82 WN20
1983	1993	CHANCE COACH	CHG-28	-	ABP N82 7220	ABP N82 WN20
2003	2003	CHANCE COACH	OPUS	-	ABP N82 7732	-
1983	1993	CHANCE COACH	VS-24	-	ABP N82 7220	ABP N82 WN20
2001	2001	CHICAGO BUS	ALL MODELS	-	ABP N82 7724	ABP N82 W24
1969	1981	CROWN COACH	TRANSIT BUS	-	ABP N82 7220	ABP N82 WN20



BUS

HEAVY-DUTY APPLICATION GUIDE

RV

RV

START	END	MAKE	MODEL	UNIVERSAL	HEAVY-DUTY	WINTER
1994	1994	AEROSPORT	HAWK	-	ABP N82 7724	ABP N82 W24
2005	2006	AIRSTREAM	A-SERIES	-	ABP N82 7728	ABP N82 W28
1989	1990	AIRSTREAM	AIRSTREAM 350	-	ABP N82 7220	ABP N82 WN20
1996	2000	AIRSTREAM	ALL CLASS C CHEVY CHASSIS	ABP N82 7622	-	ABP N82 W22
1996	1997	AIRSTREAM	ALL CLASS C FORD CHASSIS	ABP N82 7622	-	ABP N82 W22
1998	2000	AIRSTREAM	ALL CLASS C FORD CHASSIS	ABP N82 7620	-	ABP N82 W20
1975	1980	AIRSTREAM	ALL CLASS A MOTOR HOMES	-	ABP N82 7220	ABP N82 WN20
1999	2000	AIRSTREAM	CUTTER BUS	-	ABP N82 7728	ABP N82 W28
2004	2007	AIRSTREAM	INTERSTATE	ABP N82 7622	-	ABP N82 W22
2004	2007	AIRSTREAM	INTERSTATE	ABP N82 7624	-	ABP N82 W24
1990	1998	AIRSTREAM	LAND YACHT	-	ABP N82 7728	ABP N82 W28
1990	1998	AIRSTREAM	LAND YACHT	-	ABP N82 7828	ABP N82 W28
1992	1995	AIRSTREAM	LEGACY	-	ABP N82 7728	ABP N82 W28
2006	2007	AIRSTREAM	PARKWAY	ABP N82 7622	-	ABP N82 W22
2006	2007	AIRSTREAM	PARKWAY	ABP N82 7624	-	ABP N82 W24
2003	2003	AIRSTREAM	SKY DECK	-	ABP N82 7728	ABP N82 W28
2005	2006	AIRSTREAM	WESTFALIA	ABP N82 7622	-	ABP N82 W22
2005	2006	AIRSTREAM	WESTFALIA	ABP N82 7624	-	ABP N82 W24
2003	2007	ALFA LEISURE	SEE YA	-	ABP N82 7726	ABP N82 W26
2007	2009	ALFA LEISURE	SEE YA	ABP N82 7626	-	ABP N82 W24
2007	2007	ALFA LEISURE	SEE YA FOUNDER	-	ABP N82 7726	ABP N82 W26
2007	2009	ALFA LEISURE	SEE YA FOUNDER	ABP N82 7626	-	ABP N82 W26
2005	2007	ALFA LEISURE	SEE YA GOLD	-	ABP N82 7726	ABP N82 W26
2007	2009	ALFA LEISURE	SEE YA GOLD	ABP N82 7626	-	ABP N82 W26
1998	1998	AMERICAN CRUISER	AMERICAN CRUISER	ABP N82 7618	-	ABP N82 W18
1999	2000	AMERICAN CRUISER	AMERICAN CRUISER	ABP N82 7619	-	ABP N82 W18
1978	1994	BARTH	ALL MODELS	-	ABP N82 7220	ABP N82 WN20
1995	1995	BARTH	ALL MODELS	-	ABP N82 7724	ABP N82 W24
1996	1996	BARTH	MONARCH	-	ABP N82 7220	ABP N82 WN20
1994	1994	BEAVER MOTOR COACHES	ACCLAIM	-	ABP N82 7724	ABP N82 W24
2003	2003	BEAVER MOTOR COACHES	BARON	-	ABP N82 7726	ABP N82 W26
1999	2000	BEAVER MOTOR COACHES	CONTESSA	-	ABP N82 7724	ABP N82 W24

HEAVY-DUTY APPLICATION GUIDE

START	END	MAKE	MODEL	UNIVERSAL	HEAVY-DUTY	WINTER
2001	2002	BEAVER MOTOR COACHES	CONTESSA	-	ABP N82 7724	ABP N82 W24
2003	2003	BEAVER MOTOR COACHES	CONTESSA	-	ABP N82 7728	ABP N82 W28
2007	2007	BEAVER MOTOR COACHES	CONTESSA	-	ABP N82 7732	-
2007	2008	BEAVER MOTOR COACHES	CONTESSA	-	ABP N82 7732	-
2009	2009	BEAVER MOTOR COACHES	CONTESSA	ABP N82 7628	-	ABP N82 W28
1999	2002	BEAVER MOTOR COACHES	MARQUIS	-	ABP N82 7724	ABP N82 W24
2000	2002	BEAVER MOTOR COACHES	MARQUIS	-	ABP N82 7724	ABP N82 W24
2003	2005	BEAVER MOTOR COACHES	MARQUIS	-	ABP N82 7728	ABP N82 W28
2006	2007	BEAVER MOTOR COACHES	MARQUIS	-	ABP N82 7732	-
2007	2007	BEAVER MOTOR COACHES	MARQUIS	-	ABP N82 7732	-
1999	2002	BEAVER MOTOR COACHES	MONTEREY	-	ABP N82 7726	ABP N82 W26
2000	2002	BEAVER MOTOR COACHES	MONTEREY	-	ABP N82 7724	ABP N82 W24
2003	2003	BEAVER MOTOR COACHES	MONTEREY	-	ABP N82 7728	ABP N82 W28
2009	2009	BEAVER MOTOR COACHES	MONTEREY	ABP N82 7628	-	ABP N82 W28
1999	2002	BEAVER MOTOR COACHES	PATRIOT	-	ABP N82 7724	ABP N82 W24
2003	2005	BEAVER MOTOR COACHES	PATRIOT	-	ABP N82 7728	ABP N82 W28
2006	2007	BEAVER MOTOR COACHES	PATRIOT	-	ABP N82 7732	-
2007	2007	BEAVER MOTOR COACHES	PATRIOT	-	ABP N82 7732	-
2003	2005	BEAVER MOTOR COACHES	SANTIUM	-	ABP N82 7724	ABP N82 W24
2002	2003	BIGFOOT IND.	3000-SERIES	ABP N82 7620	-	ABP N82 W20
2006	2007	BIGFOOT IND.	4000-SERIES	ABP N82 7622	-	ABP N82 W22
1998	1998	BIGFOOT IND.	BIGFOOT	ABP N82 7620	-	ABP N82 W20
1995	1997	BLUE BIRD	BMC	-	ABP N82 7724	ABP N82 W24
1963	1991	BLUE BIRD	WANDERLODGE	-	ABP N82 7220	ABP N82 WN20
1992	1998	BLUE BIRD	WANDERLODGE	-	ABP N82 7724	ABP N82 W24
1999	1999	BLUE BIRD	WANDERLODGE	-	ABP N82 7728	ABP N82 W28
2000	2003	BLUE BIRD	WANDERLODGE	ABP N82 7626	-	ABP N82 W26
2001	2001	BLUE BIRD	WANDERLODGE	-	ABP N82 7726	ABP N82 W26
2005	2006	BLUE BIRD	WANDERLODGE	-	ABP N82 7728	ABP N82 W28
1998	1998	BONANZA COACH	BONANZA (DODGE)	ABP N82 7618	-	ABP N82 W18

HEAVY-DUTY APPLICATION GUIDE

RV

RV

START	END	MAKE	MODEL	UNIVERSAL	HEAVY-DUTY	WINTER
1999	2000	BONANZA COACH	BONANZA (DODGE)	ABP N82 7619	-	ABP N82 W18
1995	1997	BORN FREE	BORN FREE (FORD)	ABP N82 7622	-	ABP N82 W22
1998	1999	BORN FREE	BORN FREE (FORD)	ABP N82 7620	-	ABP N82 W20
1990	1990	BRAVO	ALL MODELS	-	ABP N82 7726	ABP N82 W26
1993	1997	CARRIAGE	CALLISTA (FORD)	ABP N82 7622	-	ABP N82 W22
1977	1982	CHAMPION	25	ABP N82 7620	-	ABP N82 W20
2007	2010	CHEVROLET	TILTMASER (W3500, W4500, W5500)	ABP N82 7620	-	ABP N82 W20
1996	1997	CHINOOK	ALL (CHEVROLET & FORD)	ABP N82 7622	-	ABP N82 W22
2000	2003	CHINOOK	BAJA (FORD)	ABP N82 7620	-	ABP N82 W20
2003	2003	CHINOOK	CASCADE	ABP N82 7622	-	ABP N82 W22
1998	2003	CHINOOK	CONCOURSE (FORD)	ABP N82 7620	-	ABP N82 W20
2001	2003	CHINOOK	DESTINY	ABP N82 7622	-	ABP N82 W22
2003	2007	CHINOOK	GLACIER	ABP N82 7620	-	ABP N82 W20
1998	2003	CHINOOK	PREMIER	ABP N82 7620	-	ABP N82 W20
2004	2007	CHINOOK	SUMMIT	ABP N82 7620	-	ABP N82 W20
1991	1992	COACH HOUSE	COACH HOUSE (CHEVY)	ABP N82 7616	-	ABP N82 W16
1993	1995	COACH HOUSE	COACH HOUSE (CHEVY)	ABP N82 7618	-	ABP N82 W18
1996	1999	COACH HOUSE	COACH HOUSE (CHEVY)	ABP N82 7622	-	ABP N82 W22
1991	1995	COACH HOUSE	COACH HOUSE (DODGE)	ABP N82 7616	-	ABP N82 W16
1995	1999	COACH HOUSE	COACH HOUSE (DODGE)	ABP N82 7618	-	ABP N82 W18
1991	1991	COACH HOUSE	COACH HOUSE (FORD)	ABP N82 7618	-	ABP N82 W18
1992	1997	COACH HOUSE	COACH HOUSE (FORD)	ABP N82 7622	-	ABP N82 W22
1998	1999	COACH HOUSE	COACH HOUSE (FORD)	ABP N82 7620	-	ABP N82 W20
2000	2003	COACH HOUSE	PLATINUM	ABP N82 7620	-	ABP N82 W20
2002	2002	COACHMEN	AURORA	-	ABP N82 7728	ABP N82 W28
2007	2007	COACHMEN	AURORA	-	ABP N82 7732	-
2007	2009	COACHMEN	AURORA	-	ABP N82 7732	-
1984	1987	COACHMEN	CATALINA	-	ABP N82 7220	ABP N82 WN20
1990	1997	COACHMEN	CATALINA	-	ABP N82 7724	ABP N82 W24
1998	1999	COACHMEN	CATALINA	-	ABP N82 7728	ABP N82 W28
2000	2000	COACHMEN	CATALINA	-	ABP N82 7726	ABP N82 W26
1988	1991	COACHMEN	CATALINA (CHEVY)	ABP N82 7616	-	ABP N82 W16

HEAVY-DUTY APPLICATION GUIDE

START	END	MAKE	MODEL	UNIVERSAL	HEAVY-DUTY	WINTER
1988	1991	COACHMEN	CATALINA (FORD)	ABP N82 7618	-	ABP N82 W18
1992	1992	COACHMEN	CATALINA SPORT (CHEVY)	ABP N82 7616	-	ABP N82 W16
1993	1995	COACHMEN	CATALINA SPORT (CHEVY)	ABP N82 7618	-	ABP N82 W18
1996	2003	COACHMEN	CATALINA SPORT (CHEVY)	ABP N82 7622	-	ABP N82 W22
1992	1997	COACHMEN	CATALINA SPORT (FORD)	ABP N82 7622	-	ABP N82 W22
1998	2003	COACHMEN	CATALINA SPORT (FORD)	ABP N82 7620	-	ABP N82 W20
2004	2004	COACHMEN	CHEYENNE	ABP N82 7620	-	ABP N82 W20
1984	1987	COACHMEN	CLASSIC	-	ABP N82 7220	ABP N82 WN20
1989	1989	COACHMEN	CLASSIC	-	ABP N82 7726	ABP N82 W26
2002	2006	COACHMEN	CROSS COUNTRY	-	ABP N82 7728	ABP N82 W28
1993	1994	COACHMEN	DESTINY	-	ABP N82 7724	ABP N82 W24
1995	1997	COACHMEN	DESTINY	-	ABP N82 7728	ABP N82 W28
2006	2007	COACHMEN	EPIC	-	ABP N82 7732	-
2007	2007	COACHMEN	EPIC	-	ABP N82 7732	-
2003	2003	COACHMEN	FREEDOM	ABP N82 7622	-	ABP N82 W22
2007	2007	COACHMEN	FREELANDER	ABP N82 7622	-	ABP N82 W22
1976	1988	COACHMEN	LEPRECHAUN (CHEVY)	ABP N82 7616	-	ABP N82 W16
1976	1981	COACHMEN	LEPRECHAUN (FORD)	ABP N82 7620	-	ABP N82 W20
1981	1991	COACHMEN	LEPRECHAUN (FORD)	ABP N82 7618	-	ABP N82 W18
1992	1997	COACHMEN	LEPRECHAUN (FORD)	ABP N82 7622	-	ABP N82 W22
1998	2003	COACHMEN	LEPRECHAUN (FORD)	ABP N82 7620	-	ABP N82 W20
1996	1997	COACHMEN	MIRADA	-	ABP N82 7724	ABP N82 W24
1998	2003	COACHMEN	MIRADA	-	ABP N82 7726	ABP N82 W26
2004	2006	COACHMEN	MIRADA	-	ABP N82 7728	ABP N82 W28
2007	2007	COACHMEN	MIRADA	-	ABP N82 7732	-
2007	2011	COACHMEN	MIRADA	-	ABP N82 7732	-
2012	2012	COACHMEN	MIRADA	ABP N82 7628	-	ABP N82 W28
2010	2012	COACHMEN	PATHFINDER	ABP N82 7628	-	ABP N82 W28
2002	2004	COACHMEN	RENDEZVOUS	-	ABP N82 7728	ABP N82 W28
2004	2005	COACHMEN	ROADMASTER	-	ABP N82 7728	ABP N82 W28
1993	1993	COACHMEN	ROYAL	-	ABP N82 7724	ABP N82 W24
1993	1993	COACHMEN	ROYAL & ROYAL RD	-	ABP N82 7724	ABP N82 W24
1992	1993	COACHMEN	ROYAL LEPRECHAUN	ABP N82 7622	-	ABP N82 W22

9

RV

HEAVY-DUTY APPLICATION GUIDE

START	END	MAKE	MODEL	UNIVERSAL	HEAVY-DUTY	WINTER
1992	1994	COACHMEN	SANTARA	-	ABP N82 7726	ABP N82 W26
1995	1997	COACHMEN	SANTARA	-	ABP N82 7728	ABP N82 W28
1998	1999	COACHMEN	SANTARA	-	ABP N82 7726	ABP N82 W26
1999	2003	COACHMEN	SANTARA	-	ABP N82 7726	ABP N82 W26
2000	2005	COACHMEN	SANTARA	-	ABP N82 7728	ABP N82 W28
1993	1993	COACHMEN	SPORTSCOACH	-	ABP N82 7726	ABP N82 W26
1999	2006	COACHMEN	SPORTSCOACH	-	ABP N82 7728	ABP N82 W28
2007	2007	COACHMEN	SPORTSCOACH	-	ABP N82 7732	-
2010	2011	COACHMEN	SPORTSCOACH	-	ABP N82 7732	-
1998	1999	COACHMEN	STARFLYTE	ABP N82 7620	-	ABP N82 W20
1987	1992	COBRA	AMERICAN (CHEVY)	ABP N82 7616	-	ABP N82 W16
1987	1991	COBRA	AMERICAN (FORD)	ABP N82 7618	-	ABP N82 W18
1992	1992	COBRA	AMERICAN (FORD)	ABP N82 7622	-	ABP N82 W22
1996	1997	COBRA	COBRA (CHEVY & FORD)	ABP N82 7622	-	ABP N82 W22
1994	1995	COBRA	CORDOBA	-	ABP N82 7422	ABP N82 W22
1991	1992	COBRA	LAGUNA (FORD)	ABP N82 7622	-	ABP N82 W22
1994	1995	COBRA	MONTEREY	-	ABP N82 7422	ABP N82 W22
1994	1994	COBRA	PASSPORT (CHEVY)	ABP N82 7618	-	ABP N82 W18
1994	1995	COBRA	PASSPORT (FORD)	ABP N82 7622	-	ABP N82 W22
1992	1995	COBRA	PHOENIX	-	ABP N82 7422	ABP N82 W22
1993	1995	COBRA	RIVIERA	-	ABP N82 7422	ABP N82 W22
1993	1994	COBRA	SEVEN SEAS	ABP N82 7622	-	ABP N82 W22
1993	1994	COBRA	SEVEN SEAS (FORD)	ABP N82 7622	-	ABP N82 W22
1997	1997	COUNTRY CLUB	CAPRI	-	ABP N82 7724	ABP N82 W24
1994	2004	COUNTRY COACH	AFFINITY	-	ABP N82 7726	ABP N82 W26
2005	2006	COUNTRY COACH	AFFINITY	-	ABP N82 7728	ABP N82 W28
2007	2007	COUNTRY COACH	AFFINITY	-	ABP N82 7732	-
2007	2008	COUNTRY COACH	AFFINITY	-	ABP N82 7732	-
1997	2004	COUNTRY COACH	ALLURE	-	ABP N82 7726	ABP N82 W26
2007	2009	COUNTRY COACH	ALLURE	-	ABP N82 7826	ABP N82 W26
1994	1999	COUNTRY COACH	CONCEPT	-	ABP N82 7726	ABP N82 W26
2007	2009	COUNTRY COACH	INSPIRE	-	ABP N82 7826	ABP N82 W26

HEAVY-DUTY APPLICATION GUIDE

START	END	MAKE	MODEL	UNIVERSAL	HEAVY-DUTY	WINTER
1994	1994	COUNTRY COACH	INTRIGUE	-	ABP N82 7726	ABP N82 W26
1995	1995	COUNTRY COACH	INTRIGUE	-	ABP N82 7724	ABP N82 W24
1996	2004	COUNTRY COACH	INTRIGUE	-	ABP N82 7726	ABP N82 W26
2007	2007	COUNTRY COACH	INTRIGUE	-	ABP N82 7826	ABP N82 W26
2008	2009	COUNTRY COACH	INTRIGUE	-	ABP N82 7732	-
2002	2004	COUNTRY COACH	LEXA	-	ABP N82 7732	-
1994	2004	COUNTRY COACH	MAGNA	-	ABP N82 7726	ABP N82 W26
2005	2007	COUNTRY COACH	MAGNA	-	ABP N82 7728	ABP N82 W28
2007	2007	COUNTRY COACH	MAGNA	-	ABP N82 7826	ABP N82 W26
2008	2009	COUNTRY COACH	MAGNA	-	ABP N82 7732	-
1998	1999	COUNTRY COACH	MAX 30	ABP N82 7620	-	ABP N82 W20
2002	2002	COUNTRY COACH	MYSTIQUE	-	ABP N82 7726	ABP N82 W26
2007	2008	COUNTRY COACH	PREVOST	-	ABP N82 7826	ABP N82 W26
2007	2008	COUNTRY COACH	TRIBUTE	-	ABP N82 7826	ABP N82 W26
1996	1997	DAMON	ALL CHEVY & FORD	ABP N82 7622	-	ABP N82 W22
2005	2005	DAMON	ASTORIA	-	ABP N82 7726	ABP N82 W26
2007	2011	DAMON	ASTORIA	-	ABP N82 7732	-
2009	2011	DAMON	AVANTI	-	ABP N82 7732	-
1994	1998	DAMON	CHALLENGER	-	ABP N82 7724	ABP N82 W24
1999	2006	DAMON	CHALLENGER	-	ABP N82 7726	ABP N82 W26
2007	2007	DAMON	CHALLENGER	-	ABP N82 7728	ABP N82 W28
2008	2012	DAMON	CHALLENGER	-	ABP N82 7732	-
1996	2000	DAMON	DAYBREAK	-	ABP N82 7724	ABP N82 W24
2001	2006	DAMON	DAYBREAK	-	ABP N82 7726	ABP N82 W26
2007	2007	DAMON	DAYBREAK	-	ABP N82 7728	ABP N82 W28
2008	2012	DAMON	DAYBREAK	-	ABP N82 7732	-
2000	2006	DAMON	ESCAPER	-	ABP N82 7726	ABP N82 W26
1986	1990	DAMON	ESCAPER (CHEVY)	ABP N82 7616	-	ABP N82 W16
1986	1990	DAMON	ESCAPER (FORD)	ABP N82 7618	-	ABP N82 W18
2008	2010	DAMON	ESSENCE	-	ABP N82 7732	-
1994	1995	DAMON	HORNET (CHEVY)	ABP N82 7618	-	ABP N82 W18

9

RV

HEAVY-DUTY APPLICATION GUIDE

START	END	MAKE	MODEL	UNIVERSAL	HEAVY-DUTY	WINTER
1994	1995	DAMON	HORNET (FORD)	ABP N82 7622	-	ABP N82 W22
1994	1994	DAMON	INTRUDER	ABP N82 7622	-	ABP N82 W22
1994	1998	DAMON	INTRUDER	-	ABP N82 7724	ABP N82 W24
1999	2006	DAMON	INTRUDER	-	ABP N82 7726	ABP N82 W26
2007	2007	DAMON	INTRUDER	-	ABP N82 7728	ABP N82 W28
1995	1995	DAMON	INVERNESS	-	ABP N82 7724	ABP N82 W24
1989	1993	DAMON	MAGNUM (CHEVY)	ABP N82 7616	-	ABP N82 W16
1981	1991	DAMON	MAGNUM (FORD)	ABP N82 7618	-	ABP N82 W18
1992	1993	DAMON	MAGNUM (FORD)	ABP N82 7622	-	ABP N82 W22
2007	2007	DAMON	OUTLAW	-	ABP N82 7728	ABP N82 W28
2008	2011	DAMON	OUTLAW	-	ABP N82 7732	-
2008	2009	DAMON	SCORPION	-	ABP N82 7732	-
2005	2007	DAMON	TUSCANY	-	ABP N82 7728	ABP N82 W28
2007	2007	DAMON	TUSCANY	-	ABP N82 7728	ABP N82 W28
2008	2011	DAMON	TUSCANY	-	ABP N82 7732	-
1994	1998	DAMON	ULTRASPORT	-	ABP N82 7724	ABP N82 W24
1999	2006	DAMON	ULTRASPORT	-	ABP N82 7726	ABP N82 W26
1994	1995	DAMON	ULTRASPORT (CHEVY)	ABP N82 7618	-	ABP N82 W18
1996	1999	DAMON	ULTRASPORT (CHEVY)	ABP N82 7622	-	ABP N82 W22
1994	1997	DAMON	ULTRASPORT (FORD)	ABP N82 7622	-	ABP N82 W22
1998	1999	DAMON	ULTRASPORT (FORD)	ABP N82 7620	-	ABP N82 W20
1993	1996	DUTCHMAN	ALL MODELS	-	ABP N82 7724	ABP N82 W24
2005	2006	DYNAMAX	CARRI-GO	ABP N82 7620	-	ABP N82 W20
2002	2003	DYNAMAX	CARRI-GO (CHEVY)	ABP N82 7622	-	ABP N82 W22
2002	2003	DYNAMAX	CARRI-GO (FORD)	ABP N82 7620	-	ABP N82 W20
2005	2007	DYNAMAX	DYNAQUEST	ABP N82 7620	-	ABP N82 W20
2005	2007	DYNAMAX	DYNAQUEST	ABP N82 7622	-	ABP N82 W22
2009	2011	DYNAMAX	DYNAQUEST	ABP N82 7622	-	ABP N82 W22
2002	2003	DYNAMAX	GRAND SPORT	ABP N82 7624	-	ABP N82 W24
2005	2007	DYNAMAX	GRAND SPORT	ABP N82 7622	-	ABP N82 W22
2009	2011	DYNAMAX	GRAND SPORT	ABP N82 7622	-	ABP N82 W22
2005	2007	DYNAMAX	ISATA	ABP N82 7620	-	ABP N82 W20
1999	2003	DYNAMAX	ISATA SPORT SEDAN (CHEVY)	ABP N82 7622	-	ABP N82 W22
1999	2003	DYNAMAX	ISATA SPORT SEDAN (FORD)	ABP N82 7620	-	ABP N82 W20

HEAVY-DUTY APPLICATION GUIDE

START	END	MAKE	MODEL	UNIVERSAL	HEAVY-DUTY	WINTER
1999	2001	DYNAMAX	ISATA TOURING SEDAN	-	ABP N82 7222	ABP N82 WN22
2001	2003	DYNAMAX	STARFLYTE (CHEVY)	ABP N82 7622	-	ABP N82 W22
2001	2003	DYNAMAX	STARFLYTE (FORD)	ABP N82 7620	-	ABP N82 W20
1994	1994	EL DORADO	ALL-CLASS A MOTOR HOMES	-	ABP N82 7422	ABP N82 W22
1990	1990	EL DORADO	EL DORADO 28	-	ABP N82 7122	ABP N82 WN22
1987	1987	EL DORADO	ENCORE	-	ABP N82 7122	ABP N82 WN22
2001	2002	EURO-LINER	EURO	-	ABP N82 7726	ABP N82 W26
1994	1997	FIRAN	ALL MODELS	-	ABP N82 7724	ABP N82 W24
2009	2009	FLEETWOOD	AMERICAN ALLEGGANCE	-	ABP N82 7826	ABP N82 W26
1995	2003	FLEETWOOD	AMERICAN DREAM	-	ABP N82 7726	ABP N82 W26
1991	2003	FLEETWOOD	AMERICAN EAGLE	-	ABP N82 7726	ABP N82 W26
2004	2007	FLEETWOOD	AMERICAN EAGLE	-	ABP N82 7726	ABP N82 W26
2007	2008	FLEETWOOD	AMERICAN EAGLE	-	ABP N82 7826	ABP N82 W26
2009	2012	FLEETWOOD	AMERICAN EAGLE	ABP N82 7628	-	ABP N82 W28
1995	1995	FLEETWOOD	AMERICAN FLYER	-	ABP N82 7726	ABP N82 W26
2000	2003	FLEETWOOD	AMERICAN HERITAGE	-	ABP N82 7726	ABP N82 W26
2005	2007	FLEETWOOD	AMERICAN HERITAGE	-	ABP N82 7726	ABP N82 W26
2007	2008	FLEETWOOD	AMERICAN HERITAGE	-	ABP N82 7826	ABP N82 W26
2009	2012	FLEETWOOD	AMERICAN HERITAGE	ABP N82 7628	-	ABP N82 W28
1996	2004	FLEETWOOD	AMERICAN TRADITION	-	ABP N82 7726	ABP N82 W26
2005	2007	FLEETWOOD	AMERICAN TRADITION	-	ABP N82 7726	ABP N82 W26
2007	2008	FLEETWOOD	AMERICAN TRADITION	-	ABP N82 7826	ABP N82 W26
2009	2012	FLEETWOOD	AMERICAN TRADITION	ABP N82 7628	-	ABP N82 W28
1987	1990	FLEETWOOD	BOUNDER	-	ABP N82 7220	ABP N82 WN20
1990	2007	FLEETWOOD	BOUNDER	-	ABP N82 7726	ABP N82 W26
2007	2009	FLEETWOOD	BOUNDER	-	ABP N82 7826	ABP N82 W26
2010	2012	FLEETWOOD	BOUNDER	-	ABP N82 7732	-
2010	2011	FLEETWOOD	BOUNDER CLASSIC	-	ABP N82 7826	ABP N82 W26
2012	2012	FLEETWOOD	BOUNDER CLASSIC	-	ABP N82 7732	-
1990	1991	FLEETWOOD	CAMBRIA	ABP N82 7620	-	ABP N82 W20
1992	1995	FLEETWOOD	CORONADO	-	ABP N82 7422	ABP N82 W22
1996	1999	FLEETWOOD	DISCOVERY	-	ABP N82 7726	ABP N82 W26
2000	2002	FLEETWOOD	DISCOVERY	-	ABP N82 7726	ABP N82 W26

HEAVY-DUTY APPLICATION GUIDE

RV

RV

START	END	MAKE	MODEL	UNIVERSAL	HEAVY-DUTY	WINTER
2003	2007	FLEETWOOD	DISCOVERY	-	ABP N82 7726	ABP N82 W26
2007	2008	FLEETWOOD	DISCOVERY	-	ABP N82 7826	ABP N82 W26
2009	2012	FLEETWOOD	DISCOVERY	ABP N82 7628	-	ABP N82 W28
2010	2011	FLEETWOOD	ENCOUNTER	-	ABP N82 7732	-
2005	2007	FLEETWOOD	EXCURSION	-	ABP N82 7726	ABP N82 W26
2007	2008	FLEETWOOD	EXCURSION	-	ABP N82 7826	ABP N82 W26
2009	2011	FLEETWOOD	EXCURSION	ABP N82 7628	-	ABP N82 W28
2007	2011	FLEETWOOD	EXPEDITION	-	ABP N82 7826	ABP N82 W26
2012	2012	FLEETWOOD	EXPEDITION	-	ABP N82 7732	-
2001	2004	FLEETWOOD	FIESTA	-	ABP N82 7726	ABP N82 W26
2005	2007	FLEETWOOD	FIESTA	-	ABP N82 7726	ABP N82 W26
2007	2011	FLEETWOOD	FIESTA	-	ABP N82 7826	ABP N82 W26
1993	2006	FLEETWOOD	FLAIR	-	ABP N82 7726	ABP N82 W26
2007	2007	FLEETWOOD	FLAIR	-	ABP N82 7826	ABP N82 W26
1998	1998	FLEETWOOD	FOUR WINDS (FORD)	ABP N82 7620	-	ABP N82 W20
1983	1992	FLEETWOOD	JAMBOREE (CHEVY)	ABP N82 7616	-	ABP N82 W16
1993	1995	FLEETWOOD	JAMBOREE (CHEVY)	ABP N82 7618	-	ABP N82 W18
1996	2002	FLEETWOOD	JAMBOREE (CHEVY)	ABP N82 7622	-	ABP N82 W22
1976	1981	FLEETWOOD	JAMBOREE (FORD)	ABP N82 7620	-	ABP N82 W20
1981	1991	FLEETWOOD	JAMBOREE (FORD)	ABP N82 7618	-	ABP N82 W18
1992	1997	FLEETWOOD	JAMBOREE (FORD)	ABP N82 7622	-	ABP N82 W22
1998	2003	FLEETWOOD	JAMBOREE (FORD)	ABP N82 7620	-	ABP N82 W20
1985	1987	FLEETWOOD	LIMITED	-	ABP N82 7220	ABP N82 WN20
1988	1993	FLEETWOOD	LIMITED	-	ABP N82 7726	ABP N82 W26
1995	1995	FLEETWOOD	MONTARA	ABP N82 7622	-	ABP N82 W22
1975	1987	FLEETWOOD	PACE ARROW	-	ABP N82 7220	ABP N82 WN20
1988	2003	FLEETWOOD	PACE ARROW	-	ABP N82 7726	ABP N82 W26
2007	2008	FLEETWOOD	PACE ARROW	-	ABP N82 7826	ABP N82 W26
2009	2011	FLEETWOOD	PACE ARROW	-	ABP N82 7732	-
2003	2007	FLEETWOOD	PROVIDENCE	-	ABP N82 7726	ABP N82 W26
2007	2008	FLEETWOOD	PROVIDENCE	-	ABP N82 7826	ABP N82 W26
2009	2012	FLEETWOOD	PROVIDENCE	ABP N82 7616	-	ABP N82 W16
2002	2003	FLEETWOOD	REVOLUTION	-	ABP N82 7726	ABP N82 W26
2005	2007	FLEETWOOD	REVOLUTION	-	ABP N82 7726	ABP N82 W26
2007	2010	FLEETWOOD	REVOLUTION	-	ABP N82 7826	ABP N82 W26

HEAVY-DUTY APPLICATION GUIDE

START	END	MAKE	MODEL	UNIVERSAL	HEAVY-DUTY	WINTER
1995	1995	FLEETWOOD	SEARCHER	ABP N82 7622	-	ABP N82 W22
1975	1987	FLEETWOOD	SOUTHWIND	-	ABP N82 7220	ABP N82 WN20
1988	1991	FLEETWOOD	SOUTHWIND	-	ABP N82 7726	ABP N82 W26
1992	1996	FLEETWOOD	SOUTHWIND	-	ABP N82 7422	ABP N82 W22
1997	2007	FLEETWOOD	SOUTHWIND	-	ABP N82 7726	ABP N82 W26
2007	2008	FLEETWOOD	SOUTHWIND	-	ABP N82 7826	ABP N82 W26
2009	2012	FLEETWOOD	SOUTHWIND	-	ABP N82 7732	-
1995	2001	FLEETWOOD	SOUTHWIND STORM	-	ABP N82 7728	ABP N82 W28
1995	1997	FLEETWOOD	SPORT JAMBOREE (FORD)	ABP N82 7622	-	ABP N82 W22
2002	2006	FLEETWOOD	STORM	-	ABP N82 7726	ABP N82 W26
2011	2011	FLEETWOOD	STORM	-	ABP N82 7826	ABP N82 W26
2012	2012	FLEETWOOD	STORM	-	ABP N82 7732	-
1993	1993	FLEETWOOD	SUNSPORT	-	ABP N82 7422	ABP N82 W22
2002	2005	FLEETWOOD	TERRA	-	ABP N82 7726	ABP N82 W26
2006	2007	FLEETWOOD	TERRA	-	ABP N82 7726	ABP N82 W26
2012	2012	FLEETWOOD	TERRA	-	ABP N82 7732	-
1983	1992	FLEETWOOD	TIOGA (CHEVY)	ABP N82 7616	-	ABP N82 W16
1993	1995	FLEETWOOD	TIOGA (CHEVY)	ABP N82 7618	-	ABP N82 W18
1996	2002	FLEETWOOD	TIOGA (CHEVY)	ABP N82 7622	-	ABP N82 W22
2003	2003	FLEETWOOD	TIOGA (CHEVY)	ABP N82 7620	-	ABP N82 W20
1981	1991	FLEETWOOD	TIOGA (FORD)	ABP N82 7618	-	ABP N82 W18
1992	1997	FLEETWOOD	TIOGA (FORD)	ABP N82 7622	-	ABP N82 W22
1998	2002	FLEETWOOD	TIOGA (FORD)	ABP N82 7620	-	ABP N82 W20
2008	2012	FOREST RIVER	BERKSHIRE	-	ABP N82 7732	-
2006	2007	FOREST RIVER	CHARLESTON	-	ABP N82 7732	-
2007	2011	FOREST RIVER	CHARLESTON	-	ABP N82 7732	-
1998	1998	FOREST RIVER	GEORGETOWN	-	ABP N82 7724	ABP N82 W24
1999	2006	FOREST RIVER	GEORGETOWN	-	ABP N82 7726	ABP N82 W26
2006	2007	FOREST RIVER	GEORGETOWN	-	ABP N82 7728	ABP N82 W28
2007	2008	FOREST RIVER	GEORGETOWN	-	ABP N82 7826	ABP N82 W26
2009	2011	FOREST RIVER	GEORGETOWN	ABP N82 7628	-	ABP N82 W28
2011	2012	FOREST RIVER	GEORGETOWN	-	ABP N82 7826	ABP N82 W26
2000	2006	FOREST RIVER	REFLECTION	-	ABP N82 7726	ABP N82 W26
1998	2003	FOREST RIVER	SUNSEEKER	ABP N82 7620	-	ABP N82 W20
2002	2005	FOREST RIVER	TSUNAMI	-	ABP N82 7728	ABP N82 W28

HEAVY-DUTY APPLICATION GUIDE

START	END	MAKE	MODEL	UNIVERSAL	HEAVY-DUTY	WINTER
1998	1998	FOREST RIVER	WINDSONG	-	ABP N82 7724	ABP N82 W24
1999	2005	FOREST RIVER	WINDSONG	-	ABP N82 7726	ABP N82 W26
2003	2003	FORETRAVEL	GV320	-	ABP N82 7726	ABP N82 W26
2006	2006	FORETRAVEL	NIMBUS	-	ABP N82 7726	ABP N82 W26
2007	2007	FORETRAVEL	NIMBUS	-	ABP N82 7732	-
2006	2007	FORETRAVEL	PHENIX	-	ABP N82 7732	-
2007	2007	FORETRAVEL	PHENIX	-	ABP N82 7732	-
1994	1994	FORETRAVEL	U240	-	ABP N82 7220	ABP N82 WN20
1998	2000	FORETRAVEL	U270	-	ABP N82 7726	ABP N82 W26
2001	2003	FORETRAVEL	U270	-	ABP N82 7724	ABP N82 W24
1994	1996	FORETRAVEL	U280	-	ABP N82 7724	ABP N82 W24
1998	2005	FORETRAVEL	U295	-	ABP N82 7726	ABP N82 W26
1994	1996	FORETRAVEL	U300	-	ABP N82 7724	ABP N82 W24
1998	2005	FORETRAVEL	U320	-	ABP N82 7726	ABP N82 W26
1996	1998	FORETRAVEL	UNICOACH	-	ABP N82 7726	ABP N82 W26
1993	1994	FOUR WINDS	5000	-	ABP N82 7724	ABP N82 W24
2012	2012	FOUR WINDS	ACE	-	ABP N82 7732	-
1991	1992	FOUR WINDS	ALL (CHEVY)	ABP N82 7616	-	ABP N82 W16
1993	1995	FOUR WINDS	ALL (CHEVY)	ABP N82 7618	-	ABP N82 W18
1996	2003	FOUR WINDS	ALL (CHEVY)	ABP N82 7622	-	ABP N82 W22
1992	1997	FOUR WINDS	ALL (FORD)	ABP N82 7622	-	ABP N82 W22
1998	2003	FOUR WINDS	ALL (FORD)	ABP N82 7620	-	ABP N82 W20
1996	2003	FOUR WINDS	HURRICANE	-	ABP N82 7724	ABP N82 W24
1996	2004	FOUR WINDS	HURRICANE	-	ABP N82 7728	ABP N82 W28
2005	2006	FOUR WINDS	HURRICANE	-	ABP N82 7728	ABP N82 W28
2007	2007	FOUR WINDS	HURRICANE	-	ABP N82 7732	-
2007	2011	FOUR WINDS	HURRICANE	-	ABP N82 7732	-
1997	1998	FOUR WINDS	INFINITY	-	ABP N82 7726	ABP N82 W26
1999	1999	FOUR WINDS	INFINITY	-	ABP N82 7726	ABP N82 W26
2000	2001	FOUR WINDS	INFINITY	-	ABP N82 7724	ABP N82 W24
2002	2003	FOUR WINDS	INFINITY	-	ABP N82 7726	ABP N82 W26
2005	2006	FOUR WINDS	INFINITY	-	ABP N82 7728	ABP N82 W28
2007	2007	FOUR WINDS	MAGELLAN	-	ABP N82 7726	ABP N82 W26
2008	2010	FOUR WINDS	MAGELLAN	-	ABP N82 7732	-
2009	2012	FOUR WINDS	SERRANO	-	ABP N82 7732	-

HEAVY-DUTY APPLICATION GUIDE

START	END	MAKE	MODEL	UNIVERSAL	HEAVY-DUTY	WINTER
1999	2004	FOUR WINDS	WINDSPORT	-	ABP N82 7726	ABP N82 W26
2005	2006	FOUR WINDS	WINDSPORT	-	ABP N82 7728	ABP N82 W28
2007	2007	FOUR WINDS	WINDSPORT	-	ABP N82 7732	-
2007	2011	FOUR WINDS	WINDSPORT	-	ABP N82 7732	-
1993	1994	FOUR WINDS	XL	-	ABP N82 7724	ABP N82 W24
2004	2004	GEORGIE BOY	BELLAGIO	-	ABP N82 7726	ABP N82 W26
2005	2005	GEORGIE BOY	BELLAGIO	-	ABP N82 7728	ABP N82 W28
1977	1988	GEORGIE BOY	CRUISE AIR	-	ABP N82 7122	ABP N82 WN22
1989	1996	GEORGIE BOY	CRUISE AIR	-	ABP N82 7222	ABP N82 WN22
1998	1998	GEORGIE BOY	CRUISE AIR	-	ABP N82 7728	ABP N82 W28
1999	2004	GEORGIE BOY	CRUISE AIR	-	ABP N82 7726	ABP N82 W26
2002	2004	GEORGIE BOY	CRUISE AIR	-	ABP N82 7724	ABP N82 W24
2005	2005	GEORGIE BOY	CRUISE AIR	-	ABP N82 7728	ABP N82 W28
1977	1988	GEORGIE BOY	CRUISE MASTER	-	ABP N82 7122	ABP N82 WN22
1989	1997	GEORGIE BOY	CRUISE MASTER	-	ABP N82 7222	ABP N82 WN22
1998	2002	GEORGIE BOY	CRUISE MASTER	-	ABP N82 7726	ABP N82 W26
2003	2004	GEORGIE BOY	CRUISE MASTER	-	ABP N82 7724	ABP N82 W24
2007	2007	GEORGIE BOY	CRUISE MASTER	-	ABP N82 7732	-
2005	2006	GEORGIE BOY	CRUISE MASTER LE	-	ABP N82 7726	ABP N82 W26
2005	2006	GEORGIE BOY	CRUISE MASTER LUXURA	-	ABP N82 7732	-
1997	1997	GEORGIE BOY	CUSTOM	-	ABP N82 7422	ABP N82 W22
1986	1994	GEORGIE BOY	ENCOUNTER	-	ABP N82 7724	ABP N82 W24
1995	1997	GEORGIE BOY	ENCOUNTER	-	ABP N82 7422	ABP N82 W22
1998	1998	GEORGIE BOY	ENCOUNTER	-	ABP N82 7726	ABP N82 W26
1990	1991	GEORGIE BOY	IMPULSE	-	ABP N82 7422	ABP N82 W22
1999	1999	GEORGIE BOY	LANDAU	-	ABP N82 7422	ABP N82 W22
2001	2001	GEORGIE BOY	LANDAU	-	ABP N82 7726	ABP N82 W26
2002	2005	GEORGIE BOY	LANDAU	-	ABP N82 7724	ABP N82 W24
2005	2007	GEORGIE BOY	LANDAU	-	ABP N82 7726	ABP N82 W26
2007	2007	GEORGIE BOY	LANDAU	-	ABP N82 7826	ABP N82 W26
1996	2001	GEORGIE BOY	MAVERICK (CHEVY)	ABP N82 7622	-	ABP N82 W22
1996	1997	GEORGIE BOY	MAVERICK (FORD)	ABP N82 7622	-	ABP N82 W22
1998	2001	GEORGIE BOY	MAVERICK (FORD)	ABP N82 7620	-	ABP N82 W20
1993	1999	GEORGIE BOY	PURSUIT	-	ABP N82 7422	ABP N82 W22
2001	2004	GEORGIE BOY	PURSUIT	-	ABP N82 7726	ABP N82 W26

HEAVY-DUTY APPLICATION GUIDE

START	END	MAKE	MODEL	UNIVERSAL	HEAVY-DUTY	WINTER
2005	2007	GEORGIE BOY	PURSUIT	-	ABP N82 7724	ABP N82 W24
2007	2007	GEORGIE BOY	PURSUIT	-	ABP N82 7824	ABP N82 W24
2008	2009	GEORGIE BOY	PURSUIT	-	ABP N82 7732	-
1989	1997	GEORGIE BOY	SWINGER	-	ABP N82 7422	ABP N82 W22
2001	2001	GEORGIE BOY	THE SUITE	-	ABP N82 7726	ABP N82 W26
2002	2003	GEORGIE BOY	THE SUITE	-	ABP N82 7724	ABP N82 W24
2002	2004	GEORGIE BOY	VELOCITY	-	ABP N82 7726	ABP N82 W26
1990	1991	GRANVILLE	LEXTRA	-	ABP N82 7222	ABP N82 WN22
1987	1988	GULF STREAM	ALL-CLASS A MOTOR HOMES	ABP N82 7620	-	ABP N82 W20
2004	2005	GULF STREAM	ATRIUM	-	ABP N82 7724	ABP N82 W24
2008	2010	GULF STREAM	BOUNTY HUNTER	-	ABP N82 7726	ABP N82 W26
2009	2011	GULF STREAM	CARIBBEAN	-	ABP N82 7726	ABP N82 W26
2000	2000	GULF STREAM	CAVALIER (CHEVROLET)	ABP N82 7622	-	ABP N82 W22
2000	2000	GULF STREAM	CAVALIER (FORD)	ABP N82 7620	-	ABP N82 W20
1986	1987	GULF STREAM	CLASSIC	ABP N82 7620	-	ABP N82 W20
2000	2002	GULF STREAM	CONQUEST	-	ABP N82 7724	ABP N82 W24
1983	1992	GULF STREAM	CONQUEST (CHEVY)	ABP N82 7616	-	ABP N82 W16
1993	1995	GULF STREAM	CONQUEST (CHEVY)	ABP N82 7618	-	ABP N82 W18
1996	2003	GULF STREAM	CONQUEST (CHEVY)	ABP N82 7622	-	ABP N82 W22
1981	1991	GULF STREAM	CONQUEST (FORD)	ABP N82 7618	-	ABP N82 W18
1992	1997	GULF STREAM	CONQUEST (FORD)	ABP N82 7622	-	ABP N82 W22
1998	2003	GULF STREAM	CONQUEST (FORD)	ABP N82 7620	-	ABP N82 W20
2008	2010	GULF STREAM	CONSTELLATION	-	ABP N82 7732	-
2004	2007	GULF STREAM	CRESCENDO	-	ABP N82 7724	ABP N82 W24
2007	2007	GULF STREAM	CRESCENDO	-	ABP N82 7724	ABP N82 W24
2008	2010	GULF STREAM	CRESCENDO DIESEL PUSHER	-	ABP N82 7732	-
2008	2010	GULF STREAM	CRESCENDO FRONT ENGINE DIESEL	-	ABP N82 7726	ABP N82 W26
1990	1990	GULF STREAM	FRIENDSHIP	-	ABP N82 7220	ABP N82 WN20
1993	2006	GULF STREAM	FRIENDSHIP	-	ABP N82 7724	ABP N82 W24
2007	2007	GULF STREAM	FRIENDSHIP	-	ABP N82 7732	-
2000	2007	GULF STREAM	INDEPENDENCE	-	ABP N82 7724	ABP N82 W24
2007	2007	GULF STREAM	INDEPENDENCE	-	ABP N82 7724	ABP N82 W24
2008	2011	GULF STREAM	INDEPENDENCE	-	ABP N82 7726	ABP N82 W26
2003	2003	GULF STREAM	INDEPENDENCE (CHEVY)	ABP N82 7622	-	ABP N82 W22

HEAVY-DUTY APPLICATION GUIDE

START	END	MAKE	MODEL	UNIVERSAL	HEAVY-DUTY	WINTER
2003	2003	GULF STREAM	INDEPENDENCE (FORD)	ABP N82 7620	-	ABP N82 W20
2010	2011	GULF STREAM	MONTAJ	ABP N82 7628	-	ABP N82 W28
1999	2000	GULF STREAM	PALM BREEZE	-	ABP N82 7724	ABP N82 W24
1993	1997	GULF STREAM	SCENIC CRUISER	-	ABP N82 7724	ABP N82 W24
1999	2001	GULF STREAM	SCENIC CRUISER	-	ABP N82 7728	ABP N82 W28
2001	2005	GULF STREAM	SCENIC CRUISER	-	ABP N82 7724	ABP N82 W24
2000	2000	GULF STREAM	SPORT (FORD)	ABP N82 7620	-	ABP N82 W20
1993	1993	GULF STREAM	SUN CLIPPER	-	ABP N82 7724	ABP N82 W24
1989	1989	GULF STREAM	SUN SPORT	ABP N82 7620	-	ABP N82 W20
1993	2002	GULF STREAM	SUN SPORT	-	ABP N82 7724	ABP N82 W24
1993	1994	GULF STREAM	SUN STREAM	-	ABP N82 7724	ABP N82 W24
1989	1989	GULF STREAM	SUN VISTA	ABP N82 7620	-	ABP N82 W20
1993	2007	GULF STREAM	SUN VOYAGER	-	ABP N82 7724	ABP N82 W24
2007	2007	GULF STREAM	SUN VOYAGER	-	ABP N82 7724	ABP N82 W24
2008	2009	GULF STREAM	SUN VOYAGER	-	ABP N82 7726	ABP N82 W26
2010	2011	GULF STREAM	SUN VOYAGER	-	ABP N82 7732	-
1993	1993	GULF STREAM	TOUR MASTER	-	ABP N82 7724	ABP N82 W24
1994	2000	GULF STREAM	TOUR MASTER	-	ABP N82 7728	ABP N82 W28
2001	2002	GULF STREAM	TOUR MASTER	-	ABP N82 7724	ABP N82 W24
2007	2007	GULF STREAM	TOUR MASTER	-	ABP N82 7732	-
2007	2009	GULF STREAM	TOUR MASTER	-	ABP N82 7732	-
1983	1992	GULF STREAM	ULTRA (CHEVY)	ABP N82 7616	-	ABP N82 W16
1993	1995	GULF STREAM	ULTRA (CHEVY)	ABP N82 7618	-	ABP N82 W18
2002	2003	GULF STREAM	ULTRA (CHEVY)	ABP N82 7622	-	ABP N82 W22
1981	1991	GULF STREAM	ULTRA (FORD)	ABP N82 7618	-	ABP N82 W18
1992	1997	GULF STREAM	ULTRA (FORD)	ABP N82 7622	-	ABP N82 W22
1998	2003	GULF STREAM	ULTRA (FORD)	ABP N82 7620	-	ABP N82 W20
2001	2003	GULF STREAM	ULTRA, ULTRA SUPREME	-	ABP N82 7724	ABP N82 W24
2001	2003	GULF STREAM	YELLOWSTONE	-	ABP N82 7724	ABP N82 W24
2008	2010	GULF STREAM	YELLOWSTONE	-	ABP N82 7726	ABP N82 W26
1983	1992	GULF STREAM	YELLOWSTONE (CHEVY)	ABP N82 7616	-	ABP N82 W16
1993	1995	GULF STREAM	YELLOWSTONE (CHEVY)	ABP N82 7618	-	ABP N82 W18
1996	1996	GULF STREAM	YELLOWSTONE (CHEVY)	ABP N82 7622	-	ABP N82 W22
1992	1996	GULF STREAM	YELLOWSTONE (FORD)	ABP N82 7622	-	ABP N82 W22

9

RV

HEAVY-DUTY APPLICATION GUIDE

RV

RV

START	END	MAKE	MODEL	UNIVERSAL	HEAVY-DUTY	WINTER
1996	1997	GULF STREAM	YELLOWSTONE C.C.	-	ABP N82 7724	ABP N82 W24
1999	2000	HARNEY COACH WORKS	RENEGADE	-	ABP N82 7728	ABP N82 W28
2001	2001	HARNEY COACH WORKS	RENEGADE	-	ABP N82 7728	ABP N82 W28
2000	2001	HARNEY COACH WORKS	RIATA	-	ABP N82 7728	ABP N82 W28
1995	1996	HAWKINS MOTOR COACH	ALL MODELS	-	ABP N82 7220	ABP N82 WN20
1999	2003	HOLIDAY RAMBLER	ADMIRAL	-	ABP N82 7726	ABP N82 W26
2004	2004	HOLIDAY RAMBLER	ADMIRAL	-	ABP N82 7724	ABP N82 W24
2005	2005	HOLIDAY RAMBLER	ADMIRAL	-	ABP N82 7726	ABP N82 W26
2007	2011	HOLIDAY RAMBLER	ADMIRAL	-	ABP N82 7732	-
2001	2002	HOLIDAY RAMBLER	AMBASSADOR	-	ABP N82 7726	ABP N82 W26
2003	2003	HOLIDAY RAMBLER	AMBASSADOR	-	ABP N82 7724	ABP N82 W24
2004	2005	HOLIDAY RAMBLER	AMBASSADOR	-	ABP N82 7726	ABP N82 W26
2007	2010	HOLIDAY RAMBLER	AMBASSADOR	-	ABP N82 7732	-
2011	2012	HOLIDAY RAMBLER	AMBASSADOR	ABP N82 7628	-	ABP N82 W28
2007	2010	HOLIDAY RAMBLER	ARISTA	-	ABP N82 7726	ABP N82 W26
2002	2003	HOLIDAY RAMBLER	ATLANTIS	ABP N82 7620	-	ABP N82 W20
1994	1995	HOLIDAY RAMBLER	ENDEAVOR	-	ABP N82 7724	ABP N82 W24
1996	1996	HOLIDAY RAMBLER	ENDEAVOR	ABP N82 7622	-	ABP N82 W22
1997	2000	HOLIDAY RAMBLER	ENDEAVOR	-	ABP N82 7724	ABP N82 W24
2001	2001	HOLIDAY RAMBLER	ENDEAVOR	-	ABP N82 7422	ABP N82 W22
2002	2005	HOLIDAY RAMBLER	ENDEAVOR	-	ABP N82 7728	ABP N82 W28
2006	2007	HOLIDAY RAMBLER	ENDEAVOR	-	ABP N82 7732	-
2007	2008	HOLIDAY RAMBLER	ENDEAVOR	-	ABP N82 7732	-
2009	2012	HOLIDAY RAMBLER	ENDEAVOR	ABP N82 7628	-	ABP N82 W28
1991	1993	HOLIDAY RAMBLER	HR1000	ABP N82 7622	-	ABP N82 W22
1993	1994	HOLIDAY RAMBLER	IMPERIAL	-	ABP N82 7422	ABP N82 W22
1995	1997	HOLIDAY RAMBLER	IMPERIAL	-	ABP N82 7728	ABP N82 W28

HEAVY-DUTY APPLICATION GUIDE

START	END	MAKE	MODEL	UNIVERSAL	HEAVY-DUTY	WINTER
1998	2001	HOLIDAY RAMBLER	IMPERIAL	-	ABP N82 7726	ABP N82 W26
2002	2003	HOLIDAY RAMBLER	IMPERIAL	-	ABP N82 7732	-
2007	2007	HOLIDAY RAMBLER	IMPERIAL	-	ABP N82 7732	-
1994	2001	HOLIDAY RAMBLER	NAVIGATOR	-	ABP N82 7728	ABP N82 W28
2002	2003	HOLIDAY RAMBLER	NAVIGATOR	-	ABP N82 7732	-
2007	2007	HOLIDAY RAMBLER	NAVIGATOR	-	ABP N82 7732	-
2002	2002	HOLIDAY RAMBLER	NEPTUNE	-	ABP N82 7724	ABP N82 W24
2003	2003	HOLIDAY RAMBLER	NEPTUNE	-	ABP N82 7726	ABP N82 W26
2005	2005	HOLIDAY RAMBLER	NEPTUNE	-	ABP N82 7724	ABP N82 W24
2007	2008	HOLIDAY RAMBLER	NEPTUNE	-	ABP N82 7732	-
2009	2009	HOLIDAY RAMBLER	NEPTUNE	ABP N82 7628	-	ABP N82 W28
2002	2002	HOLIDAY RAMBLER	SCEPTER	-	ABP N82 7724	ABP N82 W24
2003	2004	HOLIDAY RAMBLER	SCEPTER	-	ABP N82 7728	ABP N82 W28
2005	2007	HOLIDAY RAMBLER	SCEPTER	-	ABP N82 7732	-
2007	2008	HOLIDAY RAMBLER	SCEPTER	-	ABP N82 7732	-
2009	2009	HOLIDAY RAMBLER	SCEPTER	ABP N82 7628	-	ABP N82 W28
2003	2004	HOLIDAY RAMBLER	TRAVELER	-	ABP N82 7726	ABP N82 W26
2011	2012	HOLIDAY RAMBLER	TRIP	ABP N82 7628	-	ABP N82 W28
1993	1996	HOLIDAY RAMBLER	VACATIONER	-	ABP N82 7422	ABP N82 W22
1997	1997	HOLIDAY RAMBLER	VACATIONER	-	ABP N82 7724	ABP N82 W24
1998	2001	HOLIDAY RAMBLER	VACATIONER	-	ABP N82 7422	ABP N82 W22
2002	2005	HOLIDAY RAMBLER	VACATIONER	-	ABP N82 7724	ABP N82 W24
2007	2007	HOLIDAY RAMBLER	VACATIONER	-	ABP N82 7826	ABP N82 W26
2008	2012	HOLIDAY RAMBLER	VACATIONER	-	ABP N82 7732	-
1998	1998	HOLIDAY RAMBLER	WINDSPORT	-	ABP N82 7726	ABP N82 W26
1990	1990	HONEY	ENTERPRISE	-	ABP N82 7724	ABP N82 W24
1990	1990	HONEY	MAXIMUM	-	ABP N82 7726	ABP N82 W26
1990	1990	HONEY	XL	-	ABP N82 7726	ABP N82 W26

9

RV

HEAVY-DUTY APPLICATION GUIDE

START	END	MAKE	MODEL	UNIVERSAL	HEAVY-DUTY	WINTER
1995	1995	HONORBUILT	EL DORADO (CHEVY)	ABP N82 7618	-	ABP N82 W18
1996	2000	HONORBUILT	EL DORADO (CHEVY)	ABP N82 7622	-	ABP N82 W22
1995	1997	HONORBUILT	EL DORADO (FORD)	ABP N82 7622	-	ABP N82 W22
1998	2000	HONORBUILT	EL DORADO (FORD)	ABP N82 7620	-	ABP N82 W20
2013	2013	INTERNATIONAL/ NAVISTAR	9900I	ABP N82 7618	-	ABP N82 W18
1994	2003	ITASCA	ALL-CLASS A MOTOR HOMES	-	ABP N82 7724	ABP N82 W24
2006	2007	ITASCA	ELLIPSE	-	ABP N82 7724	ABP N82 W24
2007	2007	ITASCA	ELLIPSE	ABP N82 7624	-	ABP N82 W24
2008	2010	ITASCA	ELLIPSE	-	ABP N82 7826	ABP N82 W26
2000	2003	ITASCA	HORIZON	-	ABP N82 7724	ABP N82 W24
2004	2004	ITASCA	HORIZON	-	ABP N82 7726	ABP N82 W26
2005	2006	ITASCA	HORIZON	-	ABP N82 7724	ABP N82 W24
2007	2012	ITASCA	HORIZON	-	ABP N82 7826	ABP N82 W26
2008	2010	ITASCA	LATITUDE	-	ABP N82 7826	ABP N82 W26
2004	2007	ITASCA	MERIDIAN	-	ABP N82 7724	ABP N82 W24
2007	2007	ITASCA	MERIDIAN	ABP N82 7624	-	ABP N82 W24
2008	2012	ITASCA	MERIDIAN	-	ABP N82 7826	ABP N82 W26
2010	2012	ITASCA	REYO	ABP N82 7628	-	ABP N82 W28
1989	1992	ITASCA	SPIRIT (CHEVY)	ABP N82 7616	-	ABP N82 W16
1993	1995	ITASCA	SPIRIT (CHEVY)	ABP N82 7618	-	ABP N82 W18
1996	2003	ITASCA	SPIRIT (CHEVY)	ABP N82 7622	-	ABP N82 W22
1989	1991	ITASCA	SPIRIT (FORD)	ABP N82 7618	-	ABP N82 W18
1992	1997	ITASCA	SPIRIT (FORD)	ABP N82 7622	-	ABP N82 W22
1998	2003	ITASCA	SPIRIT (FORD)	ABP N82 7620	-	ABP N82 W20
1989	1994	ITASCA	SPIRIT (TOYOTA)	ABP N82 7617	-	ABP N82 W16
1994	2007	ITASCA	SUN CRUISER	-	ABP N82 7724	ABP N82 W24
2007	2007	ITASCA	SUNCRUISER	ABP N82 7624	-	ABP N82 W24
2008	2012	ITASCA	SUNCRUISER	-	ABP N82 7826	ABP N82 W26
1989	1992	ITASCA	SUNDANCE (CHEVY)	ABP N82 7616	-	ABP N82 W16
1993	1995	ITASCA	SUNDANCE (CHEVY)	ABP N82 7618	-	ABP N82 W18
1996	2000	ITASCA	SUNDANCE (CHEVY)	ABP N82 7622	-	ABP N82 W22
1989	1991	ITASCA	SUNDANCE (FORD)	ABP N82 7618	-	ABP N82 W18
1992	2000	ITASCA	SUNDANCE (FORD)	ABP N82 7622	-	ABP N82 W22
2001	2003	ITASCA	SUNDANCE (FORD)	ABP N82 7620	-	ABP N82 W20
1989	1989	ITASCA	SUNFLYER	-	ABP N82 7220	ABP N82 WN20

HEAVY-DUTY APPLICATION GUIDE

START	END	MAKE	MODEL	UNIVERSAL	HEAVY-DUTY	WINTER
1990	2004	ITASCA	SUNFLYER	-	ABP N82 7724	ABP N82 W24
2003	2007	ITASCA	SUNOVA	-	ABP N82 7724	ABP N82 W24
2007	2009	ITASCA	SUNOVA	ABP N82 7624	-	ABP N82 W24
2010	2012	ITASCA	SUNOVA	-	ABP N82 7826	ABP N82 W26
1994	2007	ITASCA	SUNRISE	-	ABP N82 7724	ABP N82 W24
2007	2008	ITASCA	SUNRISE	ABP N82 7624	-	ABP N82 W24
2003	2003	ITASCA	SUNSTAR	ABP N82 7620	-	ABP N82 W20
2008	2009	ITASCA	SUNSTAR	ABP N82 7624	-	ABP N82 W24
2010	2012	ITASCA	SUNSTAR	-	ABP N82 7826	ABP N82 W26
1984	1984	ITASCA	WIND CRUISER	-	ABP N82 7220	ABP N82 WN20
2002	2003	JAYCO	AVATAR	-	ABP N82 7726	ABP N82 W26
1998	2002	JAYCO	DESIGNER	ABP N82 7620	-	ABP N82 W20
1993	1995	JAYCO	DESIGNER (CHEVY)	ABP N82 7618	-	ABP N82 W18
1996	1997	JAYCO	DESIGNER (CHEVY)	ABP N82 7622	-	ABP N82 W22
1990	1991	JAYCO	DESIGNER (FORD)	ABP N82 7618	-	ABP N82 W18
1992	1997	JAYCO	DESIGNER (FORD)	ABP N82 7622	-	ABP N82 W22
1993	1995	JAYCO	EAGLE (CHEVY)	ABP N82 7618	-	ABP N82 W18
1996	2002	JAYCO	EAGLE (CHEVY)	ABP N82 7622	-	ABP N82 W22
1993	1997	JAYCO	EAGLE (FORD)	ABP N82 7622	-	ABP N82 W22
1998	2002	JAYCO	EAGLE (FORD)	ABP N82 7620	-	ABP N82 W20
2009	2010	JAYCO	EMBARK	ABP N82 7622	-	ABP N82 W22
2002	2003	JAYCO	ESCAPADE (CHEVY)	ABP N82 7622	-	ABP N82 W22
2002	2003	JAYCO	ESCAPADE (FORD)	ABP N82 7620	-	ABP N82 W20
2002	2003	JAYCO	FIRENZA	-	ABP N82 7726	ABP N82 W26
2002	2003	JAYCO	GRANITE RIDGE	ABP N82 7620	-	ABP N82 W20
2002	2003	JAYCO	GREY HAWK (CHEVY)	ABP N82 7622	-	ABP N82 W22
2002	2003	JAYCO	GREY HAWK (FORD)	ABP N82 7620	-	ABP N82 W20
2009	2009	JAYCO	INSIGNIA	ABP N82 7628	-	ABP N82 W28
2005	2007	KING OF THE ROAD	GENESIS	-	ABP N82 7732	-
2007	2007	KING OF THE ROAD	GENESIS	-	ABP N82 7732	-
1988	1990	KOMFORT RV	KOMFORT	-	ABP N82 7422	ABP N82 W22
1981	1991	LAZY DAZE	LAZY DAZE	ABP N82 7618	-	ABP N82 W18
1983	1992	LAZY DAZE	LAZY DAZE	ABP N82 7616	-	ABP N82 W16
1965	1992	LAZY DAZE	LAZY DAZE (CHEVY)	ABP N82 7616	-	ABP N82 W16
1993	1995	LAZY DAZE	LAZY DAZE (CHEVY)	ABP N82 7618	-	ABP N82 W18

9

RV

HEAVY-DUTY APPLICATION GUIDE

9

RV

START	END	MAKE	MODEL	UNIVERSAL	HEAVY-DUTY	WINTER
1996	2002	LAZY DAZE	LAZY DAZE (CHEVY)	ABP N82 7622	-	ABP N82 W22
1981	1991	LAZY DAZE	LAZY DAZE (FORD)	ABP N82 7618	-	ABP N82 W18
1992	1997	LAZY DAZE	LAZY DAZE (FORD)	ABP N82 7622	-	ABP N82 W22
1998	2002	LAZY DAZE	LAZY DAZE (FORD)	ABP N82 7620	-	ABP N82 W20
2002	2003	LEISURE TTRAVEL	FREE SPIRIT	ABP N82 7619	-	ABP N82 W18
1998	1998	LEISURE TTRAVEL	FREEDOM	ABP N82 7618	-	ABP N82 W18
1999	2003	LEISURE TTRAVEL	FREEDOM	ABP N82 7619	-	ABP N82 W18
2002	2003	LEISURE TTRAVEL	INDEPENDENCE	ABP N82 7619	-	ABP N82 W18
2001	2001	LEISURE TTRAVEL	PLEASURE WAY	ABP N82 7619	-	ABP N82 W18
1979	1990	MALLARD	ALL-CLASS A MOTOR HOMES	-	ABP N82 7220	ABP N82 WN20
1986	1990	MALLARD	ALL-CLASS C MOTOR HOMES	ABP N82 7616	-	ABP N82 W16
2005	2006	MALLARD	MALLARD	-	ABP N82 7220	ABP N82 WN20
1990	1990	MALLARD	SPRINT	-	ABP N82 7728	ABP N82 W28
1987	1990	MALLARD	SPRINTER, XL	-	ABP N82 7220	ABP N82 WN20
2005	2006	MANDALAY	CAMELOT	-	ABP N82 7732	-
2005	2006	MANDALAY	MANDALAY	-	ABP N82 7732	-
2007	2010	MANDALAY	MANDALAY	-	ABP N82 7732	-
2007	2009	MANDALAY	PRESIDIO	-	ABP N82 7732	-
2007	2010	MANDALAY	VALENCIA	-	ABP N82 7732	-
1994	1994	MCI	MARATHON	-	ABP N82 7726	ABP N82 W26
2003	2004	MONACO	CAMELOT	-	ABP N82 7724	ABP N82 W24
2005	2007	MONACO	CAMELOT	-	ABP N82 7732	-
2007	2008	MONACO	CAMELOT	-	ABP N82 7732	-
2009	2011	MONACO	CAMELOT	ABP N82 7628	-	ABP N82 W28
2002	2002	MONACO	CAYMAN	-	ABP N82 7724	ABP N82 W24
2003	2004	MONACO	CAYMAN	-	ABP N82 7726	ABP N82 W26
2005	2005	MONACO	CAYMAN	-	ABP N82 7724	ABP N82 W24
2006	2006	MONACO	CAYMAN	-	ABP N82 7728	ABP N82 W28
2007	2009	MONACO	CAYMAN	-	ABP N82 7732	-
2010	2011	MONACO	CAYMAN	ABP N82 7628	-	ABP N82 W28
1990	1990	MONACO	CROWN ROYAL	-	ABP N82 7220	ABP N82 WN20
1999	2003	MONACO	DIPLOMAT	-	ABP N82 7724	ABP N82 W24
2004	2005	MONACO	DIPLOMAT	-	ABP N82 7728	ABP N82 W28

HEAVY-DUTY APPLICATION GUIDE

START	END	MAKE	MODEL	UNIVERSAL	HEAVY-DUTY	WINTER
2006	2006	MONACO	DIPLOMAT	-	ABP N82 7728	ABP N82 W28
2007	2008	MONACO	DIPLOMAT	-	ABP N82 7732	-
2009	2012	MONACO	DIPLOMAT	ABP N82 7628	-	ABP N82 W28
2006	2007	MONACO	DIPLOMAT (TANDEM WIPERS)	-	ABP N82 7732	-
1994	1996	MONACO	DYNASTY	-	ABP N82 7724	ABP N82 W24
1997	1998	MONACO	DYNASTY	-	ABP N82 7726	ABP N82 W26
1999	1999	MONACO	DYNASTY	-	ABP N82 7724	ABP N82 W24
2000	2007	MONACO	DYNASTY	-	ABP N82 7732	-
2007	2007	MONACO	DYNASTY	-	ABP N82 7732	-
2005	2006	MONACO	ESQUIRE	ABP N82 7620	-	ABP N82 W20
2007	2007	MONACO	EXECUTIVE	-	ABP N82 7732	-
1994	2000	MONACO	EXECUTIVE SERIES	-	ABP N82 7724	ABP N82 W24
2001	2001	MONACO	EXECUTIVE SERIES	-	ABP N82 7726	ABP N82 W26
2002	2007	MONACO	EXECUTIVE SERIES	-	ABP N82 7724	ABP N82 W24
2000	2003	MONACO	KNIGHT	-	ABP N82 7726	ABP N82 W26
2005	2005	MONACO	KNIGHT	-	ABP N82 7726	ABP N82 W26
2006	2006	MONACO	KNIGHT	-	ABP N82 7728	ABP N82 W28
2007	2011	MONACO	KNIGHT	-	ABP N82 7826	ABP N82 W26
2012	2012	MONACO	KNIGHT	-	ABP N82 7732	-
1999	2001	MONACO	LA PALMA	-	ABP N82 7726	ABP N82 W26
2002	2002	MONACO	LA PALMA	-	ABP N82 7724	ABP N82 W24
2003	2003	MONACO	LA PALMA	-	ABP N82 7726	ABP N82 W26
2004	2005	MONACO	LA PALMA	-	ABP N82 7724	ABP N82 W24
2006	2006	MONACO	LA PALMA	-	ABP N82 7728	ABP N82 W28
2007	2007	MONACO	LA PALMA	-	ABP N82 7826	ABP N82 W26
2008	2010	MONACO	LA PALMA	-	ABP N82 7732	-
2000	2003	MONACO	MONARCH	-	ABP N82 7726	ABP N82 W26
2004	2005	MONACO	MONARCH	-	ABP N82 7724	ABP N82 W24
2007	2011	MONACO	MONARCH	-	ABP N82 7732	-
2009	2011	MONACO	RIPTIDE	-	ABP N82 7726	ABP N82 W26
1994	1997	MONACO	SIGNATURE	-	ABP N82 7724	ABP N82 W24
1998	1998	MONACO	SIGNATURE	-	ABP N82 7728	ABP N82 W28
1999	2007	MONACO	SIGNATURE	-	ABP N82 7732	-
2007	2007	MONACO	SIGNATURE SERIES	-	ABP N82 7732	-
2003	2003	MONACO	SOCIALITE	-	ABP N82 7726	ABP N82 W26

9

RV

HEAVY-DUTY APPLICATION GUIDE

START	END	MAKE	MODEL	UNIVERSAL	HEAVY-DUTY	WINTER
1994	1996	MONACO	WINDSOR	-	ABP N82 7724	ABP N82 W24
1997	1998	MONACO	WINDSOR	-	ABP N82 7726	ABP N82 W26
1999	2001	MONACO	WINDSOR	-	ABP N82 7724	ABP N82 W24
2002	2006	MONACO	WINDSOR	-	ABP N82 7732	-
2011	2012	MONARCH	VESTA	ABP N82 7628	-	ABP N82 W28
1990	1990	MONITOR	CROWN IMPERIAL	-	ABP N82 7724	ABP N82 W24
1990	1990	MONITOR	IMPERIAL	-	ABP N82 7220	ABP N82 WN20
1990	1990	MONITOR	LIMITED	-	ABP N82 7724	ABP N82 W24
1999	2001	MOUNTAIN HIGH COACHWORKS	PINNACLE	-	ABP N82 7724	ABP N82 W24
2001	2001	MOUNTAIN HIGH COACHWORKS	RESIDENCY	-	ABP N82 7724	ABP N82 W24
2001	2001	MOUNTAIN HIGH COACHWORKS	SUMMIT	-	ABP N82 7732	-
1980	1994	NATIONAL RV	ALL-CLASS C MOTOR HOMES	ABP N82 7617	-	ABP N82 W16
2001	2001	NATIONAL RV	CARIBBEAN	-	ABP N82 7422	ABP N82 W22
1988	1994	NATIONAL RV	DOLPHIN	-	ABP N82 7724	ABP N82 W24
1995	2006	NATIONAL RV	DOLPHIN	-	ABP N82 7422	ABP N82 W22
2007	2007	NATIONAL RV	DOLPHIN	-	ABP N82 7726	ABP N82 W26
2007	2009	NATIONAL RV	DOLPHIN	-	ABP N82 7826	ABP N82 W26
2001	2003	NATIONAL RV	ISLANDER	-	ABP N82 7726	ABP N82 W26
1990	1991	NATIONAL RV	LAS BRISAS	-	ABP N82 7726	ABP N82 W26
1997	1998	NATIONAL RV	LIMITED	-	ABP N82 7422	ABP N82 W22
2001	2001	NATIONAL RV	MARLIN	-	ABP N82 7726	ABP N82 W26
2007	2009	NATIONAL RV	NAUTICA	-	ABP N82 7826	ABP N82 W26
2007	2007	NATIONAL RV	PACIFICA	-	ABP N82 7726	ABP N82 W26
2007	2009	NATIONAL RV	PACIFICA	-	ABP N82 7826	ABP N82 W26
1993	1993	NATIONAL RV	SEA BREEZE	-	ABP N82 7726	ABP N82 W26
1994	1994	NATIONAL RV	SEA BREEZE	-	ABP N82 7724	ABP N82 W24
1995	2007	NATIONAL RV	SEA BREEZE	-	ABP N82 7422	ABP N82 W22
2007	2007	NATIONAL RV	SEA BREEZE	ABP N82 7622	-	ABP N82 W22
1998	2001	NATIONAL RV	SEA VIEW	-	ABP N82 7422	ABP N82 W22
1999	2001	NATIONAL RV	SURF SIDE	-	ABP N82 7422	ABP N82 W22
2006	2007	NATIONAL RV	SURF SIDE	-	ABP N82 7422	ABP N82 W22
2007	2009	NATIONAL RV	SURF SIDE	ABP N82 7622	-	ABP N82 W22
1998	2001	NATIONAL RV	TRADEWINDS	-	ABP N82 7422	ABP N82 W22
2002	2006	NATIONAL RV	TRADEWINDS	-	ABP N82 7726	ABP N82 W26

HEAVY-DUTY APPLICATION GUIDE

START	END	MAKE	MODEL	UNIVERSAL	HEAVY-DUTY	WINTER
2007	2007	NATIONAL RV	TRADEWINDS	-	ABP N82 7726	ABP N82 W26
2007	2009	NATIONAL RV	TRADEWINDS	ABP N82 7626	-	ABP N82 W26
1992	1996	NATIONAL RV	TROPICAL	-	ABP N82 7422	ABP N82 W22
1997	2001	NATIONAL RV	TROPICAL	-	ABP N82 7422	ABP N82 W22
2004	2007	NATIONAL RV	TROPICAL	-	ABP N82 7726	ABP N82 W26
2007	2009	NATIONAL RV	TROPICAL	ABP N82 7626	-	ABP N82 W26
2007	2007	NEWMAR	ALL STAR	-	ABP N82 7732	-
2007	2011	NEWMAR	ALL STAR	-	ABP N82 7732	-
1980	1984	NEWMAR	ALL-CLASS A MOTOR HOMES	-	ABP N82 7218	ABP N82 WN18
1989	2001	NEWMAR	ALL-CLASS A MOTOR HOMES	-	ABP N82 7724	ABP N82 W24
1988	1990	NEWMAR	AMERICAN STAR (FORD)	ABP N82 7618	-	ABP N82 W18
2007	2007	NEWMAR	BAY STAR	-	ABP N82 7732	-
2007	2012	NEWMAR	BAY STAR	-	ABP N82 7732	-
2007	2007	NEWMAR	CANYON STAR	-	ABP N82 7732	-
2007	2012	NEWMAR	CANYON STAR	-	ABP N82 7732	-
2009	2011	NEWMAR	DUTCH AIRE	-	ABP N82 7732	-
2002	2006	NEWMAR	DUTCH STAR	-	ABP N82 7732	-
2007	2011	NEWMAR	DUTCH STAR	-	ABP N82 7732	-
2005	2006	NEWMAR	ESSEX	-	ABP N82 7732	-
2009	2011	NEWMAR	ESSEX	ABP N82 7628	-	ABP N82 W28
2008	2010	NEWMAR	GRAND STAR	-	ABP N82 7732	-
2009	2011	NEWMAR	KOUNTRY AIRE	ABP N82 7628	-	ABP N82 W28
1990	1991	NEWMAR	KOUNTRY AIRE (FORD)	ABP N82 7618	-	ABP N82 W18
1992	1993	NEWMAR	KOUNTRY AIRE (FORD)	ABP N82 7622	-	ABP N82 W22
2002	2006	NEWMAR	KOUNTRY STAR	-	ABP N82 7732	-
2007	2010	NEWMAR	KOUNTRY STAR	-	ABP N82 7732	-
1990	1990	NEWMAR	LONDON AIRE (FORD)	ABP N82 7618	-	ABP N82 W18
2002	2006	NEWMAR	MOUNTAIN AIRE	-	ABP N82 7724	ABP N82 W24
2009	2011	NEWMAR	MOUNTAIN AIRE	ABP N82 7628	-	ABP N82 W28
2002	2006	NEWMAR	MOUNTAIN AIRE DP	-	ABP N82 7732	-
2005	2005	NEWMAR	NORTHERN STAR	-	ABP N82 7732	-
2003	2006	NEWMAR	SCOTTSDALE	-	ABP N82 7732	-
2006	2007	NEWMAR	VENTANA	-	ABP N82 7732	-

9

RV

HEAVY-DUTY APPLICATION GUIDE

START	END	MAKE	MODEL	UNIVERSAL	HEAVY-DUTY	WINTER
2007	2011	NEWMAR	VENTANA	-	ABP N82 7732	-
1995	1995	ODESSA	ALL MODELS	-	ABP N82 7726	ABP N82 W26
1998	1999	ODESSA	OVERLAND COACH	-	ABP N82 7724	ABP N82 W24
1990	1990	OVERLAND	DISCOVERY	-	ABP N82 7728	ABP N82 W28
1993	1994	PATRIOT	ALL	-	ABP N82 7724	ABP N82 W24
1990	1990	PINNACLE	295T, 305Q, 320Q, 340Q	-	ABP N82 7220	ABP N82 WN20
2006	2007	PLEASURE-WAY	PLATEAU D.S.	ABP N82 7624	-	ABP N82 W24
2006	2007	PLEASURE-WAY	PLATEAU P.S.	ABP N82 7622	-	ABP N82 W22
2006	2007	PLEASURE-WAY	TRAVERSE	ABP N82 7620	-	ABP N82 W20
2005	2005	PREVOST	MARATHON COACH	-	ABP N82 7828	ABP N82 W28
1993	1995	PROVAN	TIGER (CHEVY)	ABP N82 7618	-	ABP N82 W18
1996	2000	PROVAN	TIGER (CHEVY)	ABP N82 7622	-	ABP N82 W22
1996	1997	PROVAN	TIGER (FORD)	ABP N82 7622	-	ABP N82 W22
1998	2000	PROVAN	TIGER (FORD)	ABP N82 7620	-	ABP N82 W20
2011	2012	RENEGADE	IKON	ABP N82 7622	-	ABP N82 W22
1994	2000	REXHALL	AERBUS	-	ABP N82 7726	ABP N82 W26
2001	2003	REXHALL	AERBUS	-	ABP N82 7728	ABP N82 W28
2005	2006	REXHALL	AERBUS	-	ABP N82 7732	-
2007	2007	REXHALL	AERBUS	-	ABP N82 7726	ABP N82 W26
2007	2007	REXHALL	AERBUS	ABP N82 7626	-	ABP N82 W26
1992	1993	REXHALL	AIREX	-	ABP N82 7422	ABP N82 W22
1994	1994	REXHALL	AIREX	-	ABP N82 7726	ABP N82 W26
1998	2003	REXHALL	AMERICAN CLIPPER	-	ABP N82 7726	ABP N82 W26
2001	2002	REXHALL	AMERICAN CLIPPER DP	-	ABP N82 7728	ABP N82 W28
1999	2000	REXHALL	ANTHEM	-	ABP N82 7726	ABP N82 W26
1992	2002	REXHALL	REXAIR	-	ABP N82 7726	ABP N82 W26
2003	2003	REXHALL	REXAIR	-	ABP N82 7728	ABP N82 W28
2005	2006	REXHALL	REXAIR	-	ABP N82 7732	-
2007	2007	REXHALL	REXAIR	-	ABP N82 7726	ABP N82 W26
2007	2007	REXHALL	REXAIR	ABP N82 7626	-	ABP N82 W26
1996	1996	REXHALL	ROLLS AIR	-	ABP N82 7726	ABP N82 W26
1997	1998	REXHALL	ROLLS AIR	-	ABP N82 7728	ABP N82 W28
1999	1999	REXHALL	ROSE AIR	-	ABP N82 7728	ABP N82 W28
2000	2001	REXHALL	ROSE AIR	-	ABP N82 7726	ABP N82 W26
2002	2003	REXHALL	ROSE AIR	-	ABP N82 7728	ABP N82 W28

HEAVY-DUTY APPLICATION GUIDE

START	END	MAKE	MODEL	UNIVERSAL	HEAVY-DUTY	WINTER
2005	2006	REXHALL	ROSE AIR	-	ABP N82 7732	-
2007	2007	REXHALL	ROSE AIR	-	ABP N82 7728	ABP N82 W28
2006	2007	REXHALL	RVAN D.S.	ABP N82 7624	-	ABP N82 W24
2006	2007	REXHALL	RVAN P.S	ABP N82 7622	-	ABP N82 W22
2006	2006	REXHALL	SUNSCAPE	-	ABP N82 7728	ABP N82 W28
2001	2002	REXHALL	VISION	-	ABP N82 7728	ABP N82 W28
2003	2003	REXHALL	VISION	-	ABP N82 7726	ABP N82 W26
2003	2005	REXHALL	VISION	-	ABP N82 7726	ABP N82 W26
1995	1995	ROCKWOOD	BAY PORT	-	ABP N82 7422	ABP N82 W22
1993	1993	ROCKWOOD	BEACHWOOD	-	ABP N82 7422	ABP N82 W22
1989	1990	ROCKWOOD	DRIFTWOOD	-	ABP N82 7422	ABP N82 W22
1994	1994	ROCKWOOD	EMBASSY	-	ABP N82 7422	ABP N82 W22
1993	1995	ROCKWOOD	FRONTIER (CHEVY)	ABP N82 7618	-	ABP N82 W18
1993	1994	ROCKWOOD	FRONTIER (FORD)	ABP N82 7622	-	ABP N82 W22
1993	1994	ROCKWOOD	PRESTIGE (FORD)	ABP N82 7622	-	ABP N82 W22
1993	1995	ROCKWOOD	REGENT	-	ABP N82 7422	ABP N82 W22
1989	1993	ROCKWOOD	ROCKWOOD 2000	-	ABP N82 7726	ABP N82 W26
1993	1995	ROCKWOOD	VIPER (CHEVY)	ABP N82 7618	-	ABP N82 W18
1993	1995	ROCKWOOD	VIPER (FORD)	ABP N82 7622	-	ABP N82 W22
1994	1998	SAFARI	ALL MODELS	-	ABP N82 7724	ABP N82 W24
1999	1999	SAFARI	ALL MODELS	-	ABP N82 7726	ABP N82 W26
2001	2001	SAFARI	CHEETAH	-	ABP N82 7728	ABP N82 W28
2002	2003	SAFARI	CHEETAH	-	ABP N82 7726	ABP N82 W26
2005	2005	SAFARI	CHEETAH	-	ABP N82 7728	ABP N82 W28
2007	2007	SAFARI	CHEETAH	-	ABP N82 7826	ABP N82 W26
2008	2010	SAFARI	CHEETAH	-	ABP N82 7732	-
2008	2010	SAFARI	COMPRESSION	-	ABP N82 7732	-
1994	1998	SAFARI	CONTINENTAL	-	ABP N82 7724	ABP N82 W24
1999	1999	SAFARI	CONTINENTAL	-	ABP N82 7726	ABP N82 W26
2000	2001	SAFARI	CONTINENTAL	-	ABP N82 7728	ABP N82 W28
2007	2007	SAFARI	DAMARA (C)	ABP N82 7622	-	ABP N82 W22
2007	2007	SAFARI	DAMARA (F)	ABP N82 7620	-	ABP N82 W20
2005	2005	SAFARI	GAZELLE	-	ABP N82 7724	ABP N82 W24
1994	1998	SAFARI	IVORY	-	ABP N82 7724	ABP N82 W24
2000	2001	SAFARI	IVORY	-	ABP N82 7728	ABP N82 W28

9

RV

HEAVY-DUTY APPLICATION GUIDE

RV

RV

START	END	MAKE	MODEL	UNIVERSAL	HEAVY-DUTY	WINTER
2002	2003	SAFARI	IVORY	-	ABP N82 7728	ABP N82 W28
2006	2007	SAFARI	IVORY (F)	ABP N82 7620	-	ABP N82 W20
2006	2007	SAFARI	IVORY (C)	ABP N82 7622	-	ABP N82 W22
1994	1996	SAFARI	KALAHARI	-	ABP N82 7726	ABP N82 W26
1999	2002	SAFARI	PANTHER	-	ABP N82 7728	ABP N82 W28
2003	2005	SAFARI	PANTHER	-	ABP N82 7732	-
2007	2010	SAFARI	PASSAGE	ABP N82 7626	-	ABP N82 W26
1994	1998	SAFARI	SAHARA	-	ABP N82 7724	ABP N82 W24
1999	1999	SAFARI	SAHARA	-	ABP N82 7726	ABP N82 W26
2000	2001	SAFARI	SAHARA	-	ABP N82 7728	ABP N82 W28
2002	2003	SAFARI	SAHARA	-	ABP N82 7726	ABP N82 W26
2004	2004	SAFARI	SAHARA	-	ABP N82 7724	ABP N82 W24
1994	1998	SAFARI	SERENGETI	-	ABP N82 7724	ABP N82 W24
1999	1999	SAFARI	SERENGETI	-	ABP N82 7726	ABP N82 W26
2000	2001	SAFARI	SERENGETI	-	ABP N82 7728	ABP N82 W28
2005	2005	SAFARI	SIMBA	-	ABP N82 7724	ABP N82 W24
2007	2010	SAFARI	SIMBA	-	ABP N82 7732	-
1994	2000	SAFARI	TREK	-	ABP N82 7724	ABP N82 W24
2001	2001	SAFARI	TREK	-	ABP N82 7726	ABP N82 W26
2002	2005	SAFARI	TREK	-	ABP N82 7724	ABP N82 W24
2006	2006	SAFARI	TREK	-	ABP N82 7726	ABP N82 W26
2007	2008	SAFARI	TREK	-	ABP N82 7732	-
2000	2000	SAFARI	ZANZIBAR	-	ABP N82 7728	ABP N82 W28
2001	2001	SAFARI	ZANZIBAR	-	ABP N82 7726	ABP N82 W26
2002	2003	SAFARI	ZANZIBAR	-	ABP N82 7726	ABP N82 W26
2004	2004	SAFARI	ZANZIBAR	-	ABP N82 7724	ABP N82 W24
2009	2009	SILVER CROWN	S SERIES	ABP N82 7622	-	ABP N82 W22
1990	1990	SILVER EAGLE	ALL	-	ABP N82 7220	ABP N82 WN20
2001	2001	SMC	RENEGADE	-	ABP N82 7726	ABP N82 W26
2001	2001	SMC	RIATA	-	ABP N82 7728	ABP N82 W28
1999	2006	SPORTSCOACH	ALL MODELS	-	ABP N82 7728	ABP N82 W28
1986	1987	SPORTSCOACH	CROSS COUNTRY	ABP N82 7620	-	ABP N82 W20
1990	1990	SPORTSCOACH	CROSS COUNTRY	-	ABP N82 7728	ABP N82 W28
1986	1987	SPORTSCOACH	PATHFINDER	-	ABP N82 7220	ABP N82 WN20
1990	1990	SPORTSCOACH	PATHFINDER	-	ABP N82 7728	ABP N82 W28

HEAVY-DUTY APPLICATION GUIDE

START	END	MAKE	MODEL	UNIVERSAL	HEAVY-DUTY	WINTER
1986	1987	SPORTSCOACH	SPORTSCOACH	-	ABP N82 7220	ABP N82 WN20
1990	1990	SPORTSCOACH	SPORTSCOACH IV	-	ABP N82 7726	ABP N82 W26
1990	1990	STARCRAFT	330 SB, 360 SA	-	ABP N82 7728	ABP N82 W28
1993	1993	SUN CLIPPER	ALL MODELS	-	ABP N82 7724	ABP N82 W24
1993	1995	THOR	AMBASSADOR	-	ABP N82 7728	ABP N82 W28
2000	2000	THOR	CHATEAU	ABP N82 7620	-	ABP N82 W20
1994	1996	THOR	COLUMBUS	-	ABP N82 7724	ABP N82 W24
1994	1994	THOR	DUTCHMAN	-	ABP N82 7724	ABP N82 W24
1993	1995	THOR	FOUR WINDS	-	ABP N82 7724	ABP N82 W24
1996	1997	THOR	FOUR WINDS	-	ABP N82 7726	ABP N82 W26
1996	2003	THOR	HURRICANE	-	ABP N82 7724	ABP N82 W24
1997	1999	THOR	INFINITY	-	ABP N82 7726	ABP N82 W26
2000	2001	THOR	INFINITY	-	ABP N82 7724	ABP N82 W24
2002	2003	THOR	INFINITY	-	ABP N82 7726	ABP N82 W26
1995	1996	THOR	MANOR	-	ABP N82 7728	ABP N82 W28
1995	1995	THOR	MIRAGE	-	ABP N82 7728	ABP N82 W28
1994	1999	THOR	PINNACLE	-	ABP N82 7728	ABP N82 W28
1995	1999	THOR	RESIDENCY	-	ABP N82 7728	ABP N82 W28
1972	1989	TIFFIN MOTOR HOMES	ALLEGRO	-	ABP N82 7220	ABP N82 WN20
1990	2006	TIFFIN MOTOR HOMES	ALLEGRO	-	ABP N82 7726	ABP N82 W26
2007	2008	TIFFIN MOTOR HOMES	ALLEGRO (ALL MODELS)	-	ABP N82 7732	-
2009	2012	TIFFIN MOTOR HOMES	ALLEGRO (ALL MODELS)	ABP N82 7628	-	ABP N82 W28
1996	2006	TIFFIN MOTOR HOMES	ALLEGRO BAY	-	ABP N82 7726	ABP N82 W26
1990	1995	TIFFIN MOTOR HOMES	ALLEGRO BAY (23-28)	-	ABP N82 7220	ABP N82 WN20
1990	1995	TIFFIN MOTOR HOMES	ALLEGRO BAY (30-37)	-	ABP N82 7726	ABP N82 W26
1995	2003	TIFFIN MOTOR HOMES	ALLEGRO BUS	-	ABP N82 7726	ABP N82 W26
2004	2006	TIFFIN MOTOR HOMES	ALLEGRO BUS	-	ABP N82 7728	ABP N82 W28
2007	2007	TIFFIN MOTOR HOMES	ALLEGRO BUS	-	ABP N82 7732	-
1988	1991	TIFFIN MOTOR HOMES	OPEN ROAD	-	ABP N82 7220	ABP N82 WN20
1999	2004	TIFFIN MOTOR HOMES	PHAETON	-	ABP N82 7726	ABP N82 W26
2005	2006	TIFFIN MOTOR HOMES	PHAETON	-	ABP N82 7732	-

9

RV

HEAVY-DUTY APPLICATION GUIDE

RV

RV

START	END	MAKE	MODEL	UNIVERSAL	HEAVY-DUTY	WINTER
2007	2008	TIFFIN MOTOR HOMES	PHAETON	-	ABP N82 7732	-
2009	2012	TIFFIN MOTOR HOMES	PHAETON	ABP N82 7628	-	ABP N82 W28
2000	2004	TIFFIN MOTOR HOMES	ZEPHYR	-	ABP N82 7726	ABP N82 W26
2007	2008	TIFFIN MOTOR HOMES	ZEPHYR	-	ABP N82 7732	-
2009	2012	TIFFIN MOTOR HOMES	ZEPHYR	ABP N82 7628	-	ABP N82 W28
2001	2003	TRAIL-LITE	CONDOR	-	ABP N82 7726	ABP N82 W26
2002	2002	TRAIL-LITE	STRATUS	-	ABP N82 7724	ABP N82 W24
2002	2002	TRAIL-LITE	TRAIL-LITE	-	ABP N82 7724	ABP N82 W24
1993	1994	TRAVEL CRAFT	ELITE (CHEVY)	ABP N82 7618	-	ABP N82 W18
1993	1994	TRAVEL CRAFT	ELITE (FORD)	ABP N82 7622	-	ABP N82 W22
1993	1994	TRAVEL CRAFT	TOURIST (FORD)	ABP N82 7622	-	ABP N82 W22
2007	2007	TRAVEL SUPREME	ALANTE	-	ABP N82 7732	-
2007	2009	TRAVEL SUPREME	ALANTE	-	ABP N82 7732	-
2005	2007	TRAVEL SUPREME	ENVOY	-	ABP N82 7732	-
2007	2009	TRAVEL SUPREME	ENVOY	-	ABP N82 7732	-
2007	2007	TRAVEL SUPREME	INSIGNIA	-	ABP N82 7732	-
2005	2007	TRAVEL SUPREME	MID ENGINE	-	ABP N82 7732	-
2007	2009	TRAVEL SUPREME	MID ENGINE	-	ABP N82 7732	-
2001	2007	TRAVEL SUPREME	SELECT	-	ABP N82 7732	-
2007	2008	TRAVEL SUPREME	SELECT	-	ABP N82 7732	-
2001	2007	TRAVEL SUPREME	TRAVEL SUPREME	-	ABP N82 7732	-
1986	1989	TRAVELMASTER	FREEPORT (CHEVY)	ABP N82 7616	-	ABP N82 W16
1986	1991	TRAVELMASTER	FREEPORT (FORD)	ABP N82 7618	-	ABP N82 W18
1986	1986	TRAVELMASTER	KINGSTON (FORD)	ABP N82 7618	-	ABP N82 W18
1993	1994	TRAVELMASTER	MONTEGO (CHEVY)	ABP N82 7618	-	ABP N82 W18
1993	1994	TRAVELMASTER	MONTEGO (FORD)	ABP N82 7622	-	ABP N82 W22
1987	1992	TRAVELMASTER	SIGNATURE (CHEVY)	ABP N82 7616	-	ABP N82 W16
1987	1991	TRAVELMASTER	SIGNATURE (FORD)	ABP N82 7618	-	ABP N82 W18
1992	1992	TRAVELMASTER	SIGNATURE (FORD)	ABP N82 7622	-	ABP N82 W22
1995	1995	TRAVELMASTER	TRAVELMASTER (CHEVY)	ABP N82 7618	-	ABP N82 W18

HEAVY-DUTY APPLICATION GUIDE

START	END	MAKE	MODEL	UNIVERSAL	HEAVY-DUTY	WINTER
1996	1997	TRAVELMASTER	TRAVELMASTER (CHEVY)	ABP N82 7622	-	ABP N82 W22
1992	1997	TRAVELMASTER	TRAVELMASTER (FORD)	ABP N82 7622	-	ABP N82 W22
1994	2003	TRIPLE E	ALL MODELS	-	ABP N82 7726	ABP N82 W26
1994	2002	TRIPLE E	COMMANDER	-	ABP N82 7726	ABP N82 W26
1994	2002	TRIPLE E	EMBASSY	-	ABP N82 7726	ABP N82 W26
1994	2002	TRIPLE E	EMPRESS	-	ABP N82 7726	ABP N82 W26
2004	2004	TRIPLE E	REGAL	ABP N82 7620	-	ABP N82 W20
1992	1997	TRIPLE E	SENATOR & REGENCY	ABP N82 7622	-	ABP N82 W22
1998	2003	TRIPLE E	SENATOR & REGENCY	ABP N82 7620	-	ABP N82 W20
2001	2002	TRIPLE E	SIGNATURE	-	ABP N82 7726	ABP N82 W26
2008	2011	TRIPLE E	COMMANDER	-	ABP N82 7826	ABP N82 W26
2007	2008	TRIPLE E	EMBASSY	-	ABP N82 7826	ABP N82 W26
2009	2010	TRIPLE E	EMBASSY	-	ABP N82 7826	ABP N82 W26
2009	2009	TRIPLE E	EMPRESS	-	ABP N82 7732	-
1994	1994	USA MOTOR	EUROPA 230 & 270	-	ABP N82 7724	ABP N82 W24
1996	1997	USA MOTOR	EUROPA 230, 280 & 282	ABP N82 7622	-	ABP N82 W22
2005	2006	VANGUARD	KODIAK VXL	ABP N82 7620	-	ABP N82 W20
2007	2007	WEEKEND WARRIOR	ROAD WARRIOR	ABP N82 7622	-	ABP N82 W22
1999	2003	WESTERN RV	ALPINE COACH	-	ABP N82 7728	ABP N82 W28
2004	2004	WESTERN RV	ALPINE COACH	-	ABP N82 7726	ABP N82 W26
2005	2007	WESTERN RV	ALPINE COACH	-	ABP N82 7728	ABP N82 W28
2007	2007	WESTERN RV	ALPINE COACH	-	ABP N82 7728	ABP N82 W28
2004	2007	WESTERN RV	AVALANCHE	-	ABP N82 7728	ABP N82 W28
2007	2007	WESTERN RV	AVALANCHE	-	ABP N82 7728	ABP N82 W28
2007	2007	WINNEBAGO	ACCESS (C)	ABP N82 7622	-	ABP N82 W22
2007	2007	WINNEBAGO	ACCESS (F)	ABP N82 7620	-	ABP N82 W20
1993	2003	WINNEBAGO	ADVENTURER	-	ABP N82 7724	ABP N82 W24
2007	2007	WINNEBAGO	ADVENTURER	-	ABP N82 7724	ABP N82 W24
2008	2012	WINNEBAGO	ADVENTURER	-	ABP N82 7826	ABP N82 W26
2005	2007	WINNEBAGO	ASPECT	ABP N82 7620	-	ABP N82 W20
1980	1990	WINNEBAGO	BRAVE	-	ABP N82 7220	ABP N82 WN20
1991	1996	WINNEBAGO	BRAVE	-	ABP N82 7724	ABP N82 W24
1997	1997	WINNEBAGO	BRAVE	-	ABP N82 7422	ABP N82 W22
1998	2003	WINNEBAGO	BRAVE	-	ABP N82 7724	ABP N82 W24

RV

RV

HEAVY-DUTY APPLICATION GUIDE

START	END	MAKE	MODEL	UNIVERSAL	HEAVY-DUTY	WINTER
1980	1982	WINNEBAGO	CHIEFTAIN	-	ABP N82 7120	ABP N82 WN20
1983	1990	WINNEBAGO	CHIEFTAIN	-	ABP N82 7220	ABP N82 WN20
1991	2004	WINNEBAGO	CHIEFTAIN	-	ABP N82 7724	ABP N82 W24
2010	2010	WINNEBAGO	DESTINATION	-	ABP N82 7826	ABP N82 W26
2000	2000	WINNEBAGO	DL	ABP N82 7620	-	ABP N82 W20
1983	1990	WINNEBAGO	ELANDAN	-	ABP N82 7220	ABP N82 WN20
1992	1994	WINNEBAGO	ELANTE	-	ABP N82 7724	ABP N82 W24
1999	1999	WINNEBAGO	GRAND TOUR	-	ABP N82 7724	ABP N82 W24
2000	2003	WINNEBAGO	JOURNEY	-	ABP N82 7724	ABP N82 W24
2007	2007	WINNEBAGO	JOURNEY	-	ABP N82 7724	ABP N82 W24
2008	2012	WINNEBAGO	JOURNEY	-	ABP N82 7826	ABP N82 W26
1983	1987	WINNEBAGO	LE SHARO	ABP N82 7618	-	ABP N82 W18
1988	1992	WINNEBAGO	LE SHARO (REAR)	ABP N82 7618	-	ABP N82 W18
1988	1992	WINNEBAGO	LE SHARO (FRONT)	ABP N82 7620	-	ABP N82 W20
1995	1998	WINNEBAGO	LUXOR	-	ABP N82 7724	ABP N82 W24
1995	1995	WINNEBAGO	MINNIE (CHEVY)	ABP N82 7618	-	ABP N82 W18
1996	2003	WINNEBAGO	MINNIE (CHEVY)	ABP N82 7622	-	ABP N82 W22
1995	1997	WINNEBAGO	MINNIE (FORD)	ABP N82 7622	-	ABP N82 W22
1998	2003	WINNEBAGO	MINNIE (FORD)	ABP N82 7620	-	ABP N82 W20
1989	1992	WINNEBAGO	MINNIE WINNIE (CHEVY)	ABP N82 7616	-	ABP N82 W16
1993	1995	WINNEBAGO	MINNIE WINNIE (CHEVY)	ABP N82 7618	-	ABP N82 W18
1996	2001	WINNEBAGO	MINNIE WINNIE (CHEVY)	ABP N82 7622	-	ABP N82 W22
1989	1991	WINNEBAGO	MINNIE WINNIE (FORD)	ABP N82 7618	-	ABP N82 W18
1992	1997	WINNEBAGO	MINNIE WINNIE (FORD)	ABP N82 7622	-	ABP N82 W22
1998	2003	WINNEBAGO	MINNIE WINNIE (FORD)	ABP N82 7620	-	ABP N82 W20
2006	2007	WINNEBAGO	OUTLOOK (C)	ABP N82 7622	-	ABP N82 W22
2006	2007	WINNEBAGO	OUTLOOK (F)	ABP N82 7620	-	ABP N82 W20
1995	2007	WINNEBAGO	RIALTA	ABP N82 7620	-	ABP N82 W20
2002	2007	WINNEBAGO	SIGHTSEER	-	ABP N82 7724	ABP N82 W24
2007	2009	WINNEBAGO	SIGHTSEER	ABP N82 7624	-	ABP N82 W24
2010	2012	WINNEBAGO	SIGHTSEER	-	ABP N82 7826	ABP N82 W26
2007	2007	WINNEBAGO	TOUR	-	ABP N82 7724	ABP N82 W24
2007	2010	WINNEBAGO	TOUR	-	ABP N82 7826	ABP N82 W26

HEAVY-DUTY APPLICATION GUIDE

START	END	MAKE	MODEL	UNIVERSAL	HEAVY-DUTY	WINTER
1999	2007	WINNEBAGO	ULTIMATE ADVANTAGE	-	ABP N82 7724	ABP N82 W24
1999	2003	WINNEBAGO	ULTIMATE FREEDOM	-	ABP N82 7724	ABP N82 W24
1993	1998	WINNEBAGO	VECTRA	-	ABP N82 7724	ABP N82 W24
2004	2006	WINNEBAGO	VECTRA	-	ABP N82 7724	ABP N82 W24
2007	2010	WINNEBAGO	VECTRA	-	ABP N82 7826	ABP N82 W26
2006	2007	WINNEBAGO	VIEW D.S.	ABP N82 7624	-	ABP N82 W24
2006	2007	WINNEBAGO	VIEW P.S.	ABP N82 7622	-	ABP N82 W22
2002	2003	WINNEBAGO	VISTA	ABP N82 7620	-	ABP N82 W20
2009	2012	WINNEBAGO	VISTA	-	ABP N82 7724	ABP N82 W24
2005	2007	WINNEBAGO	VOYAGE	-	ABP N82 7724	ABP N82 W24
2007	2007	WINNEBAGO	VOYAGE	-	ABP N82 7724	ABP N82 W24
1993	1997	WINNEBAGO	WARRIOR	-	ABP N82 7724	ABP N82 W24
1983	1992	WINNEBAGO	WARRIOR (CHEVY)	ABP N82 7616	-	ABP N82 W16
1993	1993	WINNEBAGO	WARRIOR (CHEVY)	ABP N82 7618	-	ABP N82 W18
1987	1994	WINNEBAGO	WARRIOR (TOYOTA)	ABP N82 7617	-	ABP N82 W16

9

RV



Find your nearest dealer at
alliancetruckparts.com



DTNA/PSM-M-990. Specifications are subject to change without notice. Copyright © Daimler Trucks North America LLC. All rights reserved. Alliance Truck Parts is a brand of Daimler Trucks North America LLC, a Daimler company. ¹For nearly all heavy-duty truck makes and models. ²See warranty for complete details and limitations.