



EasyCanner™

with Press & Forget™

Electric Water Bath Canner + Multi-Cooker

www.Ballmasonjars.com

Model EC-23-02

User Manual



Ball and Ball®, Ball Blue Book®, TMs Ball Corporation, used under license.

IMPORTANT SAFEGUARDS

Failure to follow these instructions and warnings may cause personal injury, death and/or property damage. To reduce the risk of fire, electric shock and/or injury to persons, basic safety precautions should always be followed when using electrical appliances, including the following:

1. READ ALL INSTRUCTIONS, PRODUCT LABELS AND WARNINGS BEFORE USE.
2. SAVE THESE INSTRUCTIONS IN A PLACE WHERE YOU CAN EASILY LOCATE THEM.
3. Close adult supervision is necessary when this appliance is in use or is used near children. KEEP OUT OF REACH OF CHILDREN.
4. This appliance is not to be used by persons (including children) with reduced physical, sensory or mental capabilities, or lack of experience and knowledge, unless they have been given supervision or instruction.
5. Please use extreme caution when removing lid. Burns may result from residual steam escaping from inside the pot. Lift the lid with lid bottom facing away from you and allow the drops of water to trickle back from the lid into the pot.
6. Keep hands and face away from the lid and steam vents during operation of the appliance. Do not remove the lid while water is boiling.
7. Do not touch the appliance's hot surfaces. When in use, the exterior walls and the heating unit attached to the base of the pot will become very hot to the touch. Always use the silicone handles. Do not touch hot surfaces. Use handles or knobs.
8. Do not fill pot over the max fill line indicated on the inside of the pot. Overfilling may result in boil over. Do not fill pot under the minimum fill line indicated on the inside of the pot. Underfilling may result in complete water evaporation before desired process time is complete and overheating causing permanent damage.
9. DO NOT DRY HEAT THE APPLIANCE. ALWAYS FILL THE POT FIRST WITH THE RECOMMENDED AMOUNT OF WATER OR LIQUID. Then add canning jars or other ingredients. This will help to ensure long life for your appliance.
10. Do not lift or move appliance during operation and/or while hot. If using unit for manual mode, do not transport without emptying pot of water or cooked contents.
11. Do not operate the appliance without the pot in place on the detachable base.
12. Base does not permanently attach to the pot. USE CARE WHEN LIFTING POT FROM BASE. Do not move the appliance by simply lifting it up by the handles as it easily detaches from the base.
13. Do not remove pot full of water from the base. Drain the water using the spigot prior to removing from the base.
14. While using the unit for water bath canning, please carefully follow the instructions included in this guide. Do not leave appliance unattended during the "Stand" process of canning, and immediately remove the glass lid from the pot once the "Stand" process has begun. Once the "Stand" process has completed after 5 minutes, immediately remove the jars from the pot.
15. Do not let the power cord hang over the edge of table or countertop. Do not allow the cord to come into contact with hot or wet surfaces.
16. To protect against electric shock, do not immerse the power cord, power plug, pot or detachable base in water or any other liquids.
17. Do not operate appliance with a damaged power cord or power plug, power terminals, or operate appliance after it malfunctions, or has been damaged in any manner. If damaged, please contact Ball® Consumer Service at 1-800-240-3340, Monday- Friday 9 a.m. – 5 p.m. EST.
18. Plug cord into the wall outlet. To disconnect, turn the dial counterclockwise to "Off," then remove plug from the wall outlet.
19. Unplug from outlet when not in use and before cleaning. Allow to cool before putting on or taking off parts.
20. Always use appliance in a well-ventilated area. Do not operate appliance directly under hanging cabinets.
21. Do not place any part of this appliance on or near a hot gas stove or electric burner or in a heated oven.
22. Place the appliance on a hard, flat, heat-resistant surface while in use. This will allow proper airflow underneath the appliance to keep components cool and reduce the risk of electrical fire. Do not use any manual or electrical utensils to mash, beat or puree any ingredients in the pot. This may result in damage to the heater, temperature sensor, or the spigot.
23. Place appliance on the countertop next to the sink and fill with water using a pitcher or sink spray hose. Do not place base in sink.
24. Do not use the appliance outdoors.
25. Do not use the appliance for any reason other than its intended use described in this User Manual.
26. Avoid sudden temperature changes to the glass lid and pot.
27. Only approved attachments or accessories are to be used with this appliance. Failure to use only approved attachments or accessories can lead to injury or warranty cancellation.
28. Only qualified service technicians may repair this product using authentic parts and accessories. Never attempt to disassemble or repair the unit yourself. Contact 1-800-240-3340 for Consumer Service. Hours of Operation: Monday – Friday, 9 a.m. – 5 p.m. EST.
29. To reduce the risk of electrical fire, do not place anything directly on top of the appliance or against the side of the appliance when the appliance is in operation or hot.
30. Intended for countertop use only.

31. **WARNING:** Spilled food can cause serious burns. Keep appliance and cord away from children. Never drape cord over edge of counter, never use outlet below counter and never use with an extension cord.

Please read ALL of the instructions in this manual carefully before you begin to use this appliance. Proper care and maintenance will ensure a long life and trouble-free operation for this appliance. Please save these instructions and refer to them for cleaning and care tips.



WARNING! To reduce the risk of fire or electric shock, do not remove any service covers. There are no user serviceable parts inside the Ball® EasyCanner™. Only authorized personnel should repair the appliance.

SAVE THESE INSTRUCTIONS FOR HOUSEHOLD USE ONLY

SPECIAL CORD SET INSTRUCTIONS

1. A short power-supply cord is used to reduce the risk resulting from it being grabbed by children, becoming entangled in, or tripping over a longer cord.
2. It is recommended that the appliance is only used as a single circuit device. Do not use this appliance along with other appliances on the same circuit. This could lead to an overloaded circuit and cause a fuse breaker to activate.

TABLE OF CONTENTS

IMPORTANT SAFEGUARDS	2-4
PARTS DIAGRAM	6-7
BEFORE FIRST USE	8
Cleaning Before First Use	8
Assembly	8-9
HOW TO USE FOR WATER BATH CANNING	9
Preheating Jars	9
Fill Jars with Canning Recipe	11
Processing Jars	12
HOW TO USE AS A MULTI-COOKER	15
Steaming	17
Cooking Soups & Stews	17
Boiling Pasta	17
Hot Beverages	18
Blanching	18
CARE & MAINTENANCE	19
Cleaning Your Appliance After Each Use	19
FREQUENTLY ASKED QUESTIONS (FAQs)	20
SERVICE	21
WARRANTY INFORMATION	22

RECOMMENDED ACCESSORIES (BALLMASONJARS.COM)

- Ball® Brand Secure-Grip Jar Lifter
- Ball® Bubble Remover & Headspace Tool
- Ball® Canning Rack
- Ball Blue Book® Guide To Preserving

PARTS DIAGRAM

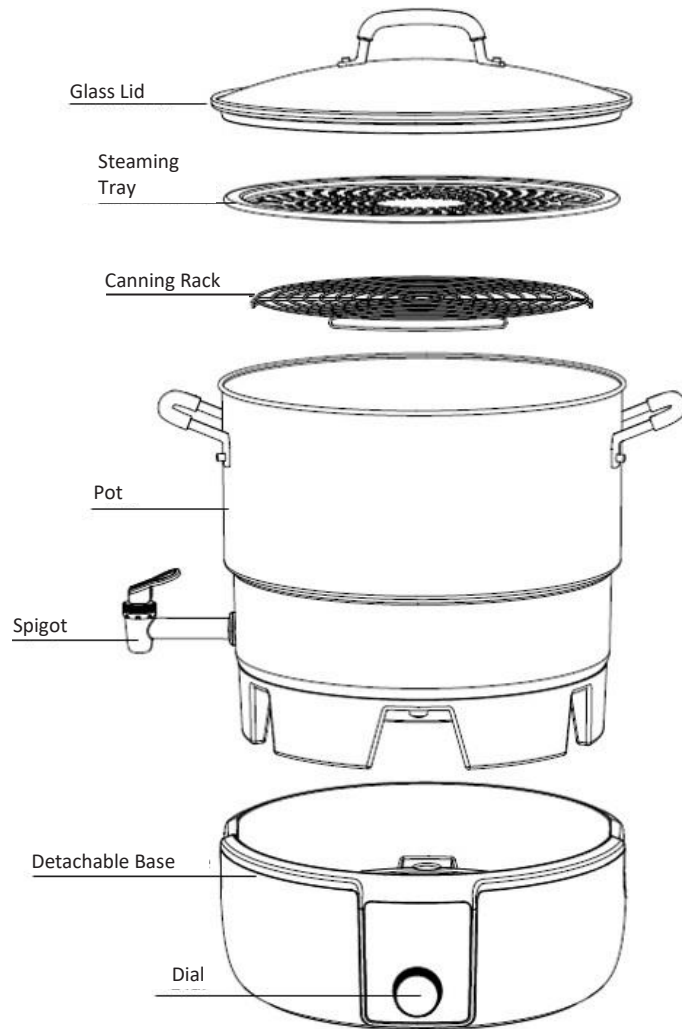

SPIGOT



1. Draining: Handle straight up
2. Closed: Handle in 10:00 position
3. Short Release: Handle down

INTERIOR POT

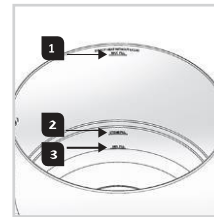

1. Max. Fill
2. Steam Fill
3. Min. Fill

Within the pot are three measurement lines: Max. Fill, Steam Fill and Min. Fill.

WATER LEVEL	PURPOSE	RISK
Max. Fill	Limit to which liquid can be filled	Overfilling may result in boil over
Steam Fill	Desired level of water needed to steam	Excessive water may result in immersion of food in water
Min. Fill	Lowest level of liquid required	Underfilling may result in complete water evaporation before desired process time and damage to the heater

Note: Do not operate the pot dry as this may damage the heating element.

STEAMING TRAY

The steaming tray featured below can be used to steam a variety of foods, such as vegetables, meat and seafood.

When processing canning jars larger than 1 pint (16 oz, 473 mL) in capacity, place the steam tray on top of the jars once they are loaded into the canner to help mitigate bubbling and splattering water during the rolling boil.

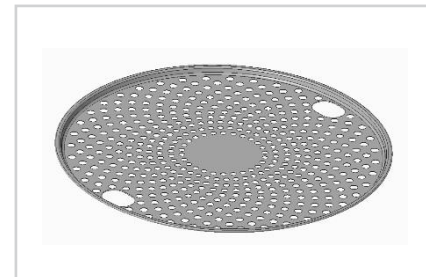

BEFORE FIRST USE

IMPORTANT NOTES:

Before using your Ball® EasyCanner™ for the first time, thoroughly review the Important Safeguards at the beginning of this User Manual.

- Keep the box and packaging materials for use at a later date, as appropriate.
- Keep this manual in an easy to locate place for future use.
- Ensure all parts illustrated on page 6 are included with the Appliance.

CLEANING BEFORE FIRST USE

Carefully clean your EasyCanner™ appliance before first use.

1. Remove all components from the box and lay out separately on the countertop next to the sink.
2. Make certain the appliance is not plugged into the power outlet before cleaning.
3. Ensure that the detachable base and power cord stay dry. DO NOT submerge the detachable base in water or place in the dishwasher.
4. Wash lid, canning rack, steaming tray and spigot (see cleaning spigot instructions on page 19) in warm soap water or dishwasher. Rinse well and dry.
5. Fill pot half-full with warm water. Add mild dish soap and wash the inside of the pot using a soft cloth. Open the spigot to let soapy water drain into the sink. Fill pot half-full with warm water. Rinse inside of pot using a clean soft cloth. Open the spigot to let water drain into the sink. Repeat process until all soap is removed from the pot.
6. All exterior surfaces of pot and base should be wiped down with a slightly damp cloth.
7. Your appliance is now ready for assembly!

ASSEMBLY

1. Place the base on the countertop next to the sink with spigot positioned over the sink and within 30in. of a power outlet.
2. To properly assemble the pot to the detachable base, align the pot's spigot with either U-shaped indent on the side of the detachable base. Then, slowly lower the pot onto the base. The spigot should sit in the U-shaped indent in the side of the base when assembled correctly. See images below.



ASSEMBLY CONTINUED

3. Testing the spigot: Ensure the spigot is closed (see page 7) and fill with approximately 2 inches of water (5 quarts). Slightly open the spigot, pressing down on the handle, ensuring the water is safely draining into the sink and not onto the sink flange or countertop. Close the spigot after testing.
4. Place canning rack into the pot with the flat surface facing up and feet resting on the bottom of the pot. To prevent damage to the spigot, ensure the canning rack or jars are not in contact with the spigot.
5. Place lid on pot.
6. Plug power cord into power outlet.

HOW TO USE FOR WATER BATH CANNING

The EasyCanner™ makes water bath canning extremely convenient. Process jams, jellies, pickles, salsas, tomatoes, and fruits (high-acid or acidified foods) using your favorite recipes found in the Ball Blue Book® Guide to Preserving as well as new and existing recipes at www.Ballmasonjars.com. The unique design of this appliance allows you to process up to 7 quart jars, 8 pint jars or 12 half-pint jars at one time.

Before Using EasyCanner™ for Water Bath Canning

1. Inspect jars for any defects such as chips or cracks. Inspect lids and bands for any defects.
2. Wash jars, lids, and bands in warm soapy water and rinse.
3. Make sure spigot handle on outside of pot is in the closed position before filling with water.

Note: the plug for the spigot inside the pot should be left unplugged to enable flow through spigot when draining water after the canning process is completed (see page 19, "Cleaning Your Appliance After Each Use").

STEP 1: PREHEATING JARS

The EasyCanner™ can be used to preheat jars prior to canning. This will reduce the risk of jar breakage from thermal shock. Follow these simple steps:

1. Following the assembly process, place the fully assembled EasyCanner™ on the countertop next to your sink. Place the canning rack with its feet touching the bottom of the pot.
2. Fill the pot half-full with warm/hot water using a pitcher or sink spray hose. Warm/hot water will decrease the amount of time necessary to bring the water to a boil.

Helpful hint: add 1/4 cup of white vinegar to the water to help prevent hard water film build up.

3. Using a jar lifter, place jars, without canning lids, on the rack. Add additional water to the pot, making sure water fills the jars and reaches the top of the jars. Water should not exceed "Max" fill line point.

Helpful hint: when placing empty jars into the canner, tilt slightly so that water can enter the jar and help weigh it down once standing upright on the rack.

- Cover the pot and turn the dial to the right (clockwise) to the "Preheat Jars" setting, then press "NEXT" on the display.

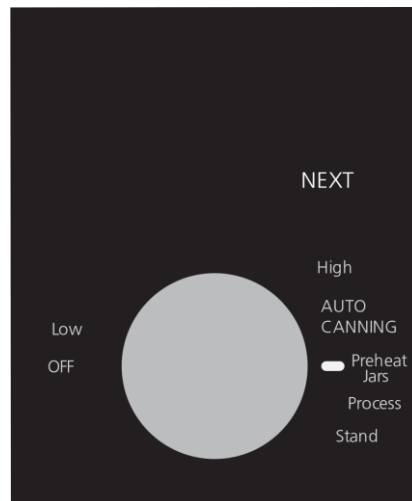

Note: if the dial is turned to "Preheat Jars" without pressing "NEXT" afterwards, the unit will enter standby after 30 seconds.

- The progress bar in the top right corner will now begin to flash and the EasyCanner™ will begin to preheat to 180 degrees (F). For water bath canning recipes that require starting from an initial temperature below 180 degrees (F), Cooking Mode should be used.

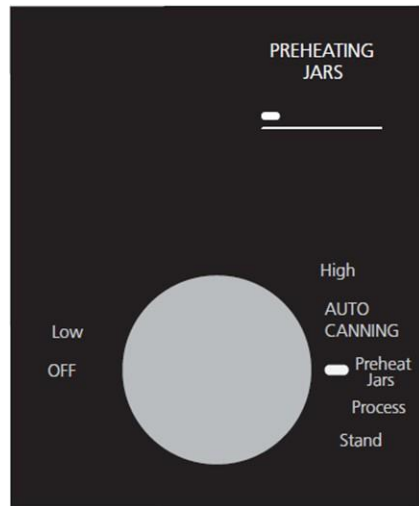

- Let the EasyCanner™ preheat until the progress bar is full and the unit beeps. The unit will then change the status to "Fill Jars". This indicates that the jars are safely preheated.

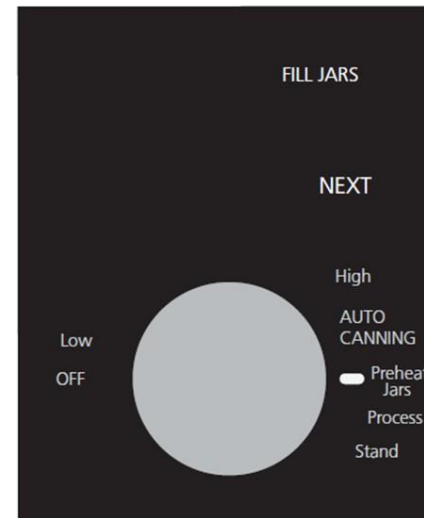

STEP 2: FILL JARS WITH CANNING RECIPE

- Using a jar lifter, remove one preheated jar at a time from the EasyCanner™. Note the jars are filled with hot water so exercise caution pouring the hot water out of the jar into the canner before removing.
- Fill just one preheated jar with prepared recipe to the correct level indicated by headspace requirements in the recipe. Each recipe will specify the correct headspace to use.
- Remove air bubbles from the jar with a Ball® Bubble Remover & Headspace Tool (sold separately) or non-metallic spatula.
- Clean jar rim and threads of jar with a clean damp cloth.
- Place a clean and new lid on the jar rim, centering the lid so that only the sealing compound is touching the jar rim. Adjust band onto jar until it is fingertip tight.
- Using a jar lifter, place filled jar onto the canning rack in center of the pot. Jar must be covered by at least 1 inch of simmering water.
- Repeat steps 2 through 6 and fill jars one at a time until all jars are placed in EasyCanner™ pot.

STEP 3: PROCESSING JARS

- Once all jars are placed in the EasyCanner™, press “NEXT” on the display. The light will move from “Preheat Jars” to “Process”. Press “NEXT” to bring up the “-” and “+” buttons.
- Using the “-” and “+” buttons, adjust the timer to the processing time indicated in your canning recipe. Press “NEXT” to begin preheating the water for processing.

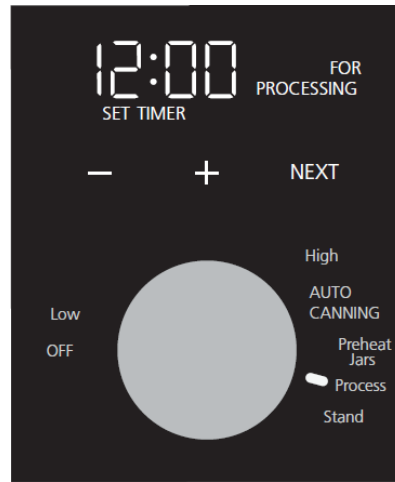

Note: Processing times given in the Ball Blue Book® Guide to Preserving, Ball® Complete Book of Home Preserving and Ballmasonjars.com are based on canning at or below 1,000 feet above sea level. When processing at altitudes higher than 1,000 feet above sea level, please adjust the processing time as follows:

- 1,001-3,000 ft. increase time by 5 minutes
- 3,001-6,000 ft. increase time by 10 minutes
- 6,001-8,000 ft. increase time by 15 minutes
- 8,001-10,000 ft. increase time by 20 minutes.

- Once you have pressed “Next”, the EasyCanner™ will begin automating the heating process. Place the lid on the top of the pot and do not remove during this time. (*Note – the Processing timer will not begin until water is preheated for processing*)

- As the EasyCanner™ increases in temperature, the progress bar will continue to fill until the water reaches a safe temperature for processing.

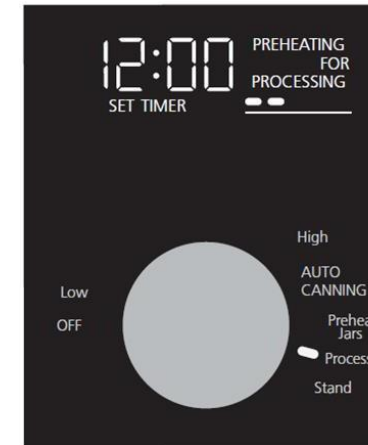

- Once all 5 progress bars are filled, the EasyCanner™ will automatically start the countdown timer and processing the jars.

Note: The bubbles that are present once the water is boiling may fluctuate in intensity. This is due to the heating cycle of the unit that is programmed to maintain the required temperature, according to the detected elevation, while limiting vigorous splashing.

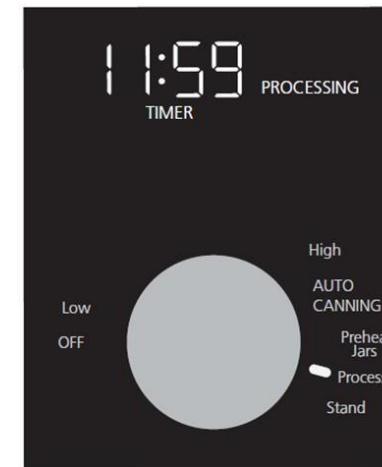

- Once the processing timer ends, the EasyCanner™ will move to “Stand” and begin the auto-cooldown process for 5 minutes. When the “Stand” process begins, immediately remove the lid from the pot while making sure the lid is facing away from you as steam may cause injury.

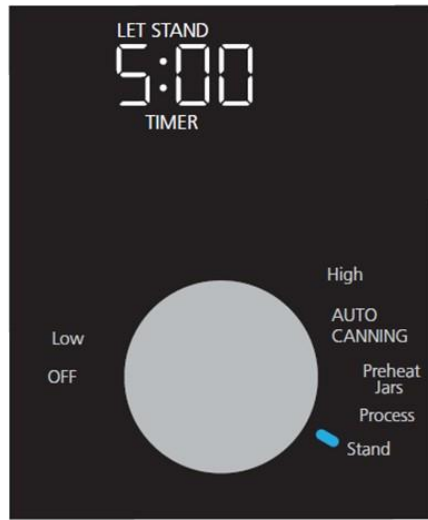

- After 5 minutes, the cooldown process will be complete, and jars can be removed from the EasyCanner™.

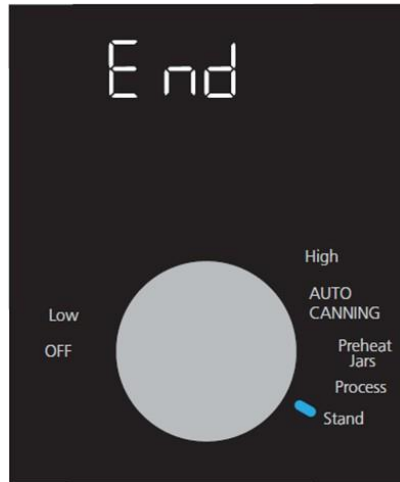

- Using a jar lifter, remove jars from canner and set upright on a dry towel or cutting board. This will prevent jar breakage that can occur from temperature differences. Leave jars undisturbed for 12 to 24 hours. DO NOT retighten bands as this may interfere with the sealing process.
- Inspect lids for seals. There should be no flex when center is pressed. Remove the bands and attempt to lift lids off with your fingertips. Properly sealed lids will remain attached. If a lid fails to seal within 24 hours, immediately refrigerate the product. Clean canning jars and lids, label and store in a cool, dry, dark place for up to 12 months when using SureTight Lids according to our instructions for Food Preservation.
- To proceed with another AUTO CANNING cycle, follow the instructions starting on page 9, "How To Use For Water Bath Canning", otherwise turn the dial counterclockwise to "OFF".

HOW TO USE AS A MULTI-COOKER

The EasyCanner™ will function in the same manner as traditional methods for steaming, cooking, boiling and blanching. Simply plug in the appliance and turn the dial to temperature based on the instructions and cooking time for your specific recipe.

After turning the dial to the desired temperature setting, press NEXT to enter "Timer Setting Mode".

Note: In cooking mode the timer is independent of temperature and will start once set.

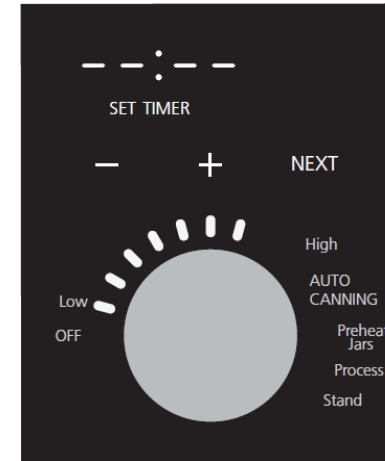

Note: if the dial is turned clockwise without pressing "NEXT" afterwards, the unit will enter standby after 30 seconds.

To set a timer, use the " - " and " + " buttons to adjust the time, then press NEXT. To proceed in Cooking Mode without setting a timer, press NEXT to bypass the timer.

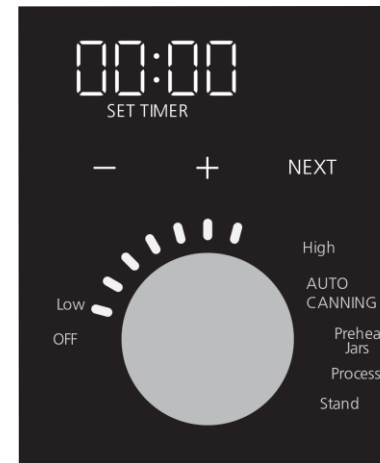

Note: If the timer is bypassed, "Timer Setting Mode" may be activated at a later point in time by pressing the " - " or " + " buttons.

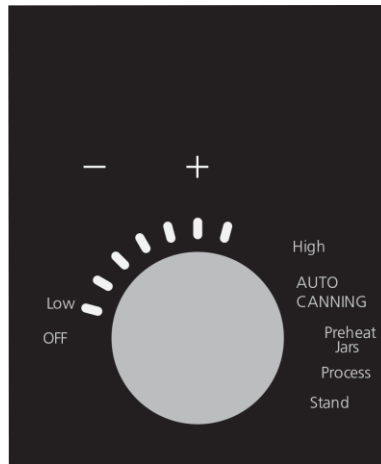

In Cooking Mode, the maximum amount of time the unit will remain “ON” for all dial settings, except HIGH, is 8 hours. The maximum amount of time the unit will remain “ON” for the HIGH setting is 6 hours. If the unit is not manually turned off using the dial prior to the maximum “ON” times, it will automatically shut off after the respective time.

Note: Due to the design of the heating element, browning meat and recipes containing high amounts of sugar, milk or cream are not recommended in this appliance, as burning or scorching may result.

COOKING MODE - TEMPERATURE SETTINGS

Please see the following guide for which target temperatures correspond with each LED light in Cooking Mode*:

DIAL SET TO:	CORRESPONDING TARGET TEMPERATURE (F)
LED Light 1 (LOW)	142 Degrees
LED Light 2	150 Degrees
LED Light 3	160 Degrees
LED Light 4	170 Degrees
LED Light 5	180 Degrees
LED Light 6	190 Degrees
LED Light 7	200 Degrees
LED Light 8	205 Degrees
LED Light 9 (HIGH)	212 Degrees (Rolling boil)

*Actual temperature at HIGH will vary depending on altitude.

Note: The HIGH setting may be used to achieve a rolling boil where the liquid bubbles actively and vigorously. Keep fill level in mind while on HIGH in Cooking Mode and use lid to mitigate bubbling accordingly.

STEAMING

Steaming food is a healthy alternative to other methods of cooking. Steam vegetables, chicken, fish or seafood in the EasyCanner™ following these simple steps.

1. Fill pot with water to the steam line before turning on the appliance.
2. Place steaming tray into the pot, resting the rack on the ridge inside.
3. Turn the dial to the right (clockwise) to **HIGH**, set or bypass the timer, press NEXT, and bring the water to a boil and to maintain a consistent production of steam. Do not turn down. Dial must remain on **HIGH** to ensure consistent boil throughout the steaming process.
4. Prepare food for steaming according to the recipe instructions. Place prepared food onto the steaming tray inside the pot. Ingredients should not be immersed in water. Place lid on pot.
5. The length of time needed to steam foods will vary depending on the food type and amount of food steamed at one time. Refer to your recipe for instructions.
6. When the steaming time is completed, carefully remove the food from the steaming tray rack inside the pot using a spoon, ladle or tongs. Continue with recipe preparation.
7. Drain remaining water in pot once cool.

COOKING SOUPS & STEWS

Cook a variety of your favorite soups, stews or chili. The EasyCanner™ is portable, so it's perfect to take to a potluck, party or large gathering!

1. Place the spigot plug into the spigot port located inside the pot. This is necessary to prevent food from entering the spigot during cooking.
2. Pour liquid ingredients of recipe into the pot before turning on the appliance. Do not sauté in bottom of pot.
3. Turn the dial to the right (clockwise) to the desired setting. Set or bypass the timer, then press NEXT. Appliance heat will cycle on and off to maintain a consistent cooking temperature.
4. Add remaining recipe ingredients and follow directions as listed, adjusting temperature, time and stirring as needed.
5. To serve, turn off heat and ladle soup, stew or chili into serving bowls. Refrigerate any remaining servings.
6. Ensure all food is removed from the pot, then remove spigot plug from the spigot port before washing pot.

BOILING PASTA

The EasyCanner™ makes boiling any variety of pasta and noodles quick and convenient.

1. Fill the pot with desired amount of water before turning on the appliance.
2. Turn the dial to the right (clockwise) to **HIGH**, set or bypass the timer, press NEXT, and bring the water to a boil. Do not turn down. Dial must remain on **HIGH** to ensure consistent boil throughout the cooking process.
3. Add pasta or noodles to boiling water and boil according to the instructions on the package. Maintain a boil throughout the cooking time.
4. Drain pasta or remove using tongs, pasta spoon or scoop colander.
5. Let the water in the pot cool. Open the spigot to drain water directly into the sink.

HOT BEVERAGES

Make delicious hot beverages in the EasyCanner™.

1. Pour liquid ingredients of recipe into the pot before turning on the appliance.
2. Turn the dial to the right (clockwise) to the desired setting, set or bypass the timer, then press NEXT.
3. Add remaining ingredients listed in the recipe, stirring to evenly incorporate all ingredients. Place lid on pot. Adjust heat and cook for length of time indicated in your recipe. Reduce heat by turning the dial left (counterclockwise) to the LOW setting to keep beverages warm.
4. Ladle or use spigot to serve beverages. When using the spigot, it is not recommended to tip the pot for serving in order to empty all the liquid. Tipping may cause the pot to detach from the base or cause damage to the unit.
5. Turn off heat before emptying pot and allow pot to cool. Clean spigot assembly by following spigot cleaning instructions on page 18.

BLANCHING

Blanch a variety of fruits and vegetables in the EasyCanner™ following these simple steps.

1. Fill pot with desired amount of water before turning on the appliance.
2. Turn the dial to the right (clockwise) to **HIGH**, set or bypass the timer, press NEXT, and bring the water to a boil. Do not turn down. Dial must remain on **HIGH** to ensure consistent boil throughout the blanching process. Prepare a large bowl of ice water.
3. Rinse, peel, pit, trim or chop as appropriate for the fruit or vegetable to be blanched and depending upon your recipe. Place produce in the boiling water for the time specified in the recipe. Maintain a boil throughout the blanching time.
4. Lift blanched produce from the pot using a skimmer or scoop strainer; let water drain off produce. Transfer produce to ice water and stir to cool evenly. Drain.
5. After all produce is blanched, turn off the appliance by turning the dial to the left (counterclockwise) to "OFF". Unplug appliance from power source. Use the spigot on the side of the pot to drain water directly into the sink once water has cooled.

Error Code Information

Please refer to the table below for error code descriptions (shown on display):

Error Code	Description	Troubleshooting Recommendations
E01	Pot is not connected to detachable base.	Lift empty pot out of base by the handles and gently place back in base.
E02	Elevation detected is beyond intended operating elevation range of 0 ft -10,000 ft. May also indicate that communication with pressure sensor has failed.	Ensure operating elevation is within 0 ft – 10,000 ft.
E03	Unit has not reached intended temperature in "AUTO CANNING" mode.	Per standard water bath canning guidelines, do not add water to pot for the rest of the AUTO CANNING cycle once "Preheating for Processing" stage has begun.
E04	Unit has reached maximum allowable operating temperature.	Ensure that water is at or above "Minimum Fill" level indicated inside the pot.

For further assistance call **Ball® Consumer Service** at 1-800-240-3340, Monday - Friday 9 a.m. - 5p.m. EST

CARE & MAINTENANCE

CLEANING YOUR APPLIANCE AFTER EACH USE



WARNING! As with all cooking appliances, the metal parts and even some plastic parts can become extremely hot to the touch. Always let the appliance cool completely – usually 20 to 30 minutes – before cleaning.

1. ALWAYS turn the dial to the "off" position (counterclockwise) and unplug your EasyCanner™ from the power source once you have completed processing your foods. Allow the appliance to cool before cleaning.
2. Remove any water left in the pot using the spigot.
3. The lid, canning rack and steaming tray can be washed in the dishwasher or with warm soapy water, rinsed and dried.
4. It is recommended that you do not expose a hot lid to cold water. Sudden temperature changes may cause damage to the lid.
5. Cleaning the pot: add water and soap to pot. Do not submerge. Clean interior pot sidewalls and bottom with a soft washcloth and use a straw cleaning brush to clean the spigot. Let water drain into sink from spigot. Add clean water/no soap to the pot. Rinse and release into sink from spigot. Repeat as needed. Wipe external areas with a damp cloth and let air-dry.
6. The detachable base may be cleaned with a soft damp cloth. Do not use abrasive cleaners. Never submerge the detachable base in water, in other liquids or place in the dishwasher.
7. Do not use abrasive cleaners or scouring pads on any Ball® parts. A cloth, sponge or rubber spatula will usually remove stubborn residue.
8. Ensure all appliance parts are thoroughly dry before storing in original box.

FAQ'S

Will the bottom burn or scratch my countertop? *No, the bottom of this appliance does not get hot and can be used on any suitable countertop surface. It also comes with small rubber pads on the bottom of the detachable base to prevent scratching the countertop.*

Will the lid and pot be hot to the touch? *Yes. The appliance gets hot similar to a stovetop canning pot. Use the silicone handles when handling the lid and pot.*

Do the handles get hot? *Your appliance was designed with heat resistant silicone handles to prevent discomfort during hot handling.*

How easy is the appliance to clean? *Easy! For cleaning convenience, the pot easily detaches from the base. The lid, canning rack and steaming tray are dishwasher safe. The pot can be hand washed with warm soapy water.*

Can I use steel wool to clean the pot? *No, this is not recommended. To remove stubborn residue, we recommend using a cloth, sponge, or rubber spatula.*

Can I drain hot water out of the spigot? *Yes, as it will not harm the spigot, but for safety, we recommend waiting until the water is cool.*

Why does water drain from my spigot when the plug is open but the spigot handle is closed? *Ensure your spigot is fully assembled by turning the textured part of the spigot just below the handle clockwise until fully tightened.*

How long does it take to drain a pot of water through the spigot? *It takes approximately 90 seconds to drain 4 quarts (1 gallon) of water. For example, it takes approximately 5-7 minutes to drain a pot of water used to process 7 quarts.*

How long is the power cord? *30 inches long.*

Can I decrease the processing time for my recipes using this appliance? *No, the time to process high-acid recipes is the same as traditional stovetop. It is important to follow the processing time recommended with each recipe.*

Can I use my existing wire canning basket in this appliance? *Yes, but the canning rack included with this appliance must first be placed in the bottom of the pot. This will prevent damage to the spigot port and allow the wire canning basket to rest flat on the bottom of the pot.*

Does the appliance save energy? *Yes, it uses less energy for heating and boiling water compared to the average 2000 watt stove.*

What recipes can be used? *High-acid recipes tested for water bath canning can be used. We recommend the recipes included in this manual, the Ball® Blue Book Guide to Preserving and those posted on www.ballmasonjars.com. For water bath canning recipes that require starting from an initial temperature below 180 degrees F, Cooking Mode should be used in a manner as you would with a boiling-water canner following standard, approved water bath canning methods and instructions.*

How many jars fit in the pot per batch? *7 quart jars, 8 pint jars or 12 half-pint jars. Additional pints or half pints will fit in the pot but are not recommended to ensure adequate water circulation.*

Can I use this appliance outside? *No. It is not recommended to use outdoors.*

Can I move the appliance while it is in operation? *No, as it will need to stay plugged into the power outlet to maintain a consistent temperature. In addition, the pot will be hot to the touch. Please see Important Safeguards on page 2.*

Can I cook food in this appliance? *Yes, this appliance is also a multi-cooker. It can be used for steaming fruits, vegetables, meat and seafood, boiling pasta, cooking stews/soups, hot beverages and blanching.*

Can I use this appliance to keep food warm? *The heating element is designed for recipes to be cooked and consumed as prepared. While serving, keep dial on LOW and stir frequently to prevent burning.*

Who can I contact if I need assistance or replacement parts? *Ball® Consumer Service at 1-800-240-3340, Monday - Friday 9 a.m. - 5 p.m. EST*

SERVICE

REPLACEMENT PARTS

Pot, Canning Rack, Steaming Tray, Glass Lid, Spigot, Spigot Plug, Detachable Base, User Manual:

Call 1-800-240-3340

To assist in serving you better, please have the EasyCanner™ model number and date of purchase available when you call. The model number is located on the bottom of the appliance base and on the cover page of this instruction manual.

**U.S. CONSUMER SERVICE
1-800-240-3340**

**HOURS OF OPERATION
Monday - Friday 9:00 a.m. - 5:00 p.m. EST**

We welcome your questions, comments or suggestions. In all your communications, please include your complete name, address and telephone number and a description of the problem.

Visit our website at www.Ballmasonjars.com and discover the secret to making water bath canning simple and convenient for all your favorite high-acid canning recipes and the latest information on Ball products.

WARRANTY INFORMATION

1-YEAR LIMITED WARRANTY

Rubbermaid Incorporated ("Rubbermaid") warrants that for a period of one year, beginning on the date of delivery to the original end user purchaser, this product will be free from defects in material and workmanship. Rubbermaid, at its option, will repair or replace, free of charge, this product or any component of the product found to be defective during the warranty period. Replacement will be made with a new product or new component at no cost to the consumer. If the product is no longer available, replacement may be made with a similar product of equal or greater value. This is your exclusive warranty. Do NOT attempt to repair or adjust any electrical or mechanical functions on this product. Rubbermaid reserves all rights to decline coverage if the defect or damage was caused by unauthorized components or service. This warranty is valid for the original retail purchaser from the date of delivery and is not transferable. Keep the original proof of purchase. Dealers, service centers, or retail stores selling Rubbermaid products do not have the right to alter, modify, or any way change the terms and conditions of this warranty. This warranty does not cover normal wear of parts or damage resulting from any of the following: negligent use or misuse of the product; use on improper voltage or current; use contrary to the operating instructions provided by Rubbermaid; disassembly, repair, or alteration by anyone other than Rubbermaid or an authorized Rubbermaid service center. Rubbermaid expressly excludes from this warranty and denies liability for defects or damage caused by repair or alteration by anyone other than Rubbermaid or an authorized Rubbermaid service center. Further, the warranty does not cover: Acts of God, such as fire, flood, hurricanes and tornadoes.

No terms of this warranty may be construed to apply to non-warranty service and maintenance. Accordingly, Rubbermaid also denies liability for defects and damage caused by repair or alteration outside the terms of this warranty.

There are no warranties which extend beyond those stated herein. ANY IMPLIED WARRANTIES THAT MAY BE APPLICABLE TO PRODUCTS, INCLUDING IMPLIED WARRANTIES OF MERCHANTABILITY OR FITNESS FOR A PARTICULAR PURPOSE, ARE LIMITED IN DURATION TO THE DURATION OF THIS WARRANTY. Some States do not allow limitations on how long an implied warranty lasts, so the above limitation may not apply to you.

UNDER NO CIRCUMSTANCES SHALL RUBBERMAID BE LIABLE FOR ANY SPECIAL, INCIDENTAL, OR CONSEQUENTIAL DAMAGES BASED UPON BREACH OF THIS LIMITED WARRANTY, BREACH OF CONTRACT, OR STRICT LIABILITY. Some States do not allow the exclusion or limitation of incidental or consequential damages, so the above limitation or exclusion may not apply to you.

This warranty gives you specific legal rights, and you may also have other rights which vary from State to State.

If you have any questions regarding this warranty or would like to obtain warranty support, please call 1.800.240.3340. Proof of purchase and proof of delivery date if different than your date of purchase is required to obtain warranty performance.

In the U.S.A. this warranty is offered by Rubbermaid Incorporated, located at 6655 Peachtree Dunwoody Rd, Atlanta, GA 30328. If you have any other problem or claim in connection with this product, please write our consumer service department.

PLEASE DO NOT RETURN THIS PRODUCT TO THE PLACE OF PURCHASE

NOTES

© 2023 RUBBERMAID INCORPORATED

PRODUCT OF: RUBBERMAID INCORPORATED

6655 PEACHTREE DUNWOODY ROAD NE

ATLANTA, GA 30328

www.ballmasonjars.com



We would love to hear from you
1-800-240-3340

Ball and Ball®, Ball Blue Book®, TMs Ball Corporation, used under license.

Connect with us:



Or for recipes or questions:
Ballmasonjars.com

Printed in China

EC-23-02_23EM1_GCDS-JC

P.N. REF000994538
Rev. A5
Model EC-23-02