

MixCal™ adjustable three-way thermostatic mixing valve

© Copyright 2015 Caleffi

521 Series

Installation, commissioning and service instructions

Function

The Caleffi MixCal™ three-way thermostatic mixing valve is used in systems producing domestic hot water or in hydronic and radiant heating systems. It maintains the desired output temperature of the mixed water supplied to the user at a constant set value compensating for both temperature and pressure fluctuations of incoming hot and cold water.



Product range

521A Series Three-way thermostatic mixing valve:

“C” models include inlet check valves “419, 519, 619” models include outlet gauge adapter. Union thread NPT Male, sizes ½”, ¾”, 1”; Union sweat, size ½”, ¾”, 1”. Press connection ¾”.



Technical Characteristics

- Materials: -Body: low-lead brass (<0.25% Lead content)
- Shutter, seats and sliding guides: PPO
- Springs: Stainless steel
- Seals: EPDM

- Suitable fluids: water, 30% max glycol solution
- Setting range (outlet temperature): 85–150°F (30–65°C)
- Tolerance: ±3°F (±2°C)
- Max working pressure (static): 200 psi (14 bar)
- Max working pressure (dynamic): 75 psi (5 bar)
- Hot water inlet temperature range: 120–185°F (49–85°C)

- Cold water inlet temperature range: 39–80°F (3.9–26.6°C)
- Maximum inlet pressure ratio (H/C or C/H) for optimum performance: 2:1
- Minimum temperature difference between hot water inlet and mixed water outlet for optimum performance: 27°F (15°C)
- Minimum flow rate to ensure optimal performance: 1.3 GPM (5 L/min)
- Lay length (¾” press connection), hot to cold inlet: 3/8”



- Maximum flow rate: 15 GPM(57 L/min)
- Certified to: cUPC listed to ASSE 1017/CSA B125.3
- Reduction of Lead in Drinking Water Act compliant: 0.25% Max. weighted average lead content

Reduction of Lead in Drinking Water Act Certified by IAPMO R&T. Meets requirements of ANSI/ NSF 372-2011.

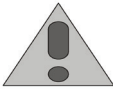

SAFETY INSTRUCTION

This safety alert symbol will be used in this manual to draw attention to safety related instructions. When used, the safety symbol means **ATTENTION! BECOME ALERT! YOUR SAFETY IS INVOLVED! FAILURE TO FOLLOW THESE INSTRUCTIONS MAY RESULT IN A SAFETY HAZARD.**

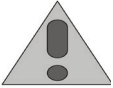

CAUTION: All work must be preformed by qualified personnel trained in the proper application, installation, and maintenance of systems in accordance with all applicable codes and ordinances.

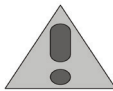

CAUTION: If the thermostatic mixing valve is not installed, commissioned and maintained properly, according to the instructions contained in this manual, it may not operate correctly and may endanger the user.

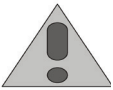

CAUTION: Make sure that all the connecting pipework is water tight.

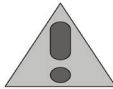

CAUTION: When making the water connections, make sure that the pipework connecting the MixCal thermostatic mixing valve is not mechanically overstressed. Over time this could cause breakages, with consequent water losses which, in turn, could cause harm to property and/or people.



CAUTION: Water temperatures higher than 100°F (38°C) can be dangerous. During the installation, commissioning and maintenance of the MixCal thermostatic mixing valve, take the necessary precautions to ensure that such temperatures do not endanger people.

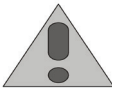

CAUTION: In the case of highly aggressive water, arrangements must be made to treat the water before it enters the thermostatic mixing valve, in accordance with current legislation. Otherwise the thermostatic mixing valve may be damaged and will not operate correctly.



CAUTION: If installed in an ASSE 1017 application, check valves shall be used.

Leave this manual for the user.

Operating principle

The controlling element of the three-way thermostatic mixing valve is a thermostatic sensor fully immersed in the mixed water outlet tube which, as it expands or contracts, continuously establishes the correct proportion of hot and cold water entering the valve. The regulation of these flows is by means of a piston sliding in a cylinder between the hot and cold water passages. Even when there are pressure drops due to the drawing off of hot or cold water for other uses, or variations in the incoming temperature, the thermostatic mixing valve automatically regulates the water flow to obtain the required temperature.

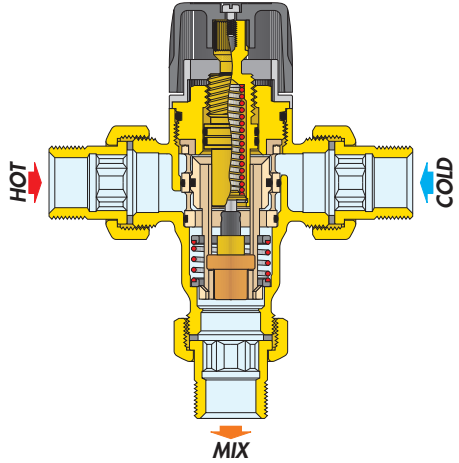

Inlet port check valve detail for 521 "AC" models

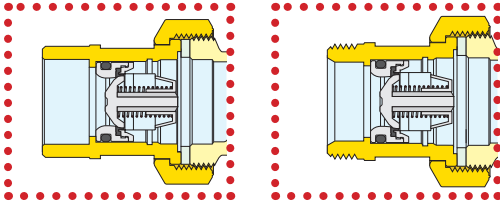

Flow curve

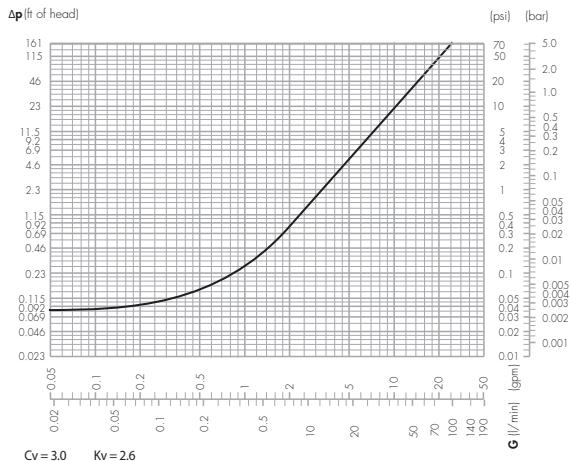

Flow should never exceed standards for pipe size and materials.

Use

 Caleffi MixCal series 521 thermostatic mixing valves are designed to be installed at the hot water heater. The Caleffi Mix Cal series 521 valve cannot be used for tempering water temperature at fixtures as a point-of-use valve. They are not designed to provide scald protection or anti-chill service. They should not be used where ASSE 1070 devices are required. Wherever a scald protection feature is required, Caleffi series 5213 high performance mixing valve needs to be installed. For safety reasons, it is advisable to limit the maximum mixed water temperature to 120°F.

Instantaneous production of hot water

Caleffi MixCal series 521 thermostatic mixing valves should not be used with boilers without storage that give you instantaneous production of domestic hot water. Their addition would compromise the correct operation of the boiler itself.

Installation

NOTE TO INSTALLER: The Caleffi MixCal series 521 thermostatic mixing valve should be installed by qualified personnel, in accordance with local codes and ordinances. It is the responsibility of the installer to properly select, install and adjust this thermostatic mixing valve as specified in these instructions.

Before installing a Caleffi MixCal series 521 thermostatic mixing valve, the system must be inspected to ensure that it's operating conditions are within the range of the thermostatic mixing valve checking, for example, the supply temperature, supply pressure, etc.

 Systems where the Caleffi MixCal series 521 thermostatic mixing valve is to be installed must be drained and cleaned out to remove any dirt or debris which may have accumulated during installation. Failure to remove dirt or debris may affect performance and the manufacturer's product guarantee. The installation of filters of appropriate capacity at the inlet of the water from the mains supply is always advisable. In area which are subject to highly aggressive water, arrangements must be made to treat the water before it enters the valve.

Caleffi MixCal series 521 thermostatic mixing valves must be installed in accordance with the diagrams in this manual, taking into account all current applicable standards.

Caleffi Mix Cal series 521 thermostatic mixing valves can be installed in any position, either vertical or horizontal.

The following are shown on the mixer body:

- Hot water inlet, color red and marker "HOT".
- Cold water inlet, color blue and marker "COLD".
- Mixed water outlet, marker "MIX".

Locking the setting

Position the handle to the number required with respect to the index point. Unscrew the head screw, pull off the handle and reposition it so that the handle fits into the internal slot of the knob. Tighten the head screw.

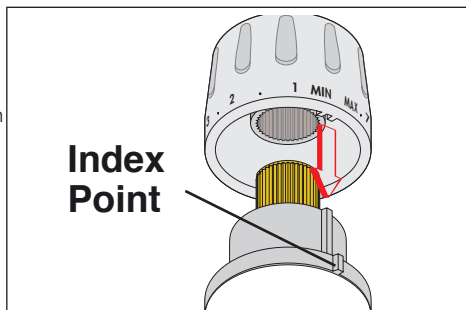

Check valves

In order to prevent undesirable backsiphonage, separate check valves should be installed in systems with code "521 A" model thermostatic mixing valves (these models do not contain integral check valves in the hot and cold inlet ports). As a convenience for easier installations, the Caleffi code "521 AC" model series thermostatic mixing valves include integral check valves in the hot and cold inlet ports.

NOTE TO INSTALLER: DO NOT TEST FIT OR INSTALL CHECK VALVES BEFORE SOLDERING. IF INSTALLED, REMOVAL WILL REQUIRE DAMAGING THE CHECK VALVE AND IT WILL NO LONGER BE USABLE.

The diagram below shows the order in which everything goes together. Note that the check valves are installed on the hot and cold inlets, the mixed outlet does not require a check valve. Note that the O-ring is installed on to the groove of the check valve.

After soldering the tailpieces into place, slide in the check valve into the tailpiece with o-ring going in first. It will click into place and then the screen will fit into the groove of the tailpiece with the domed end facing the mixing valve. Once the check valve and screen is installed, use the sealing washer between the tailpiece and mixing valve body to create a seal and tighten down the union nut.

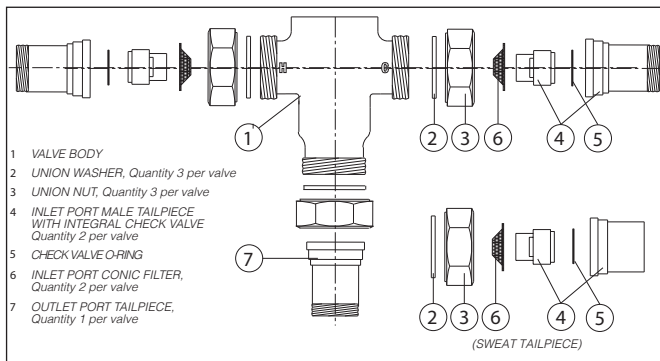

Commissioning

The special purpose of the thermostatic mixing valve must be commissioned in accordance with current standards by qualified personnel using temperature measuring equipment. Caleffi codes 521419A, 521519A, and 521619A with integral outlet port temperature gauges provide a time-saving temperature setting process to get close to the desired temperature. Use of a digital thermometer is recommended for determining the final setting of the mixed water temperature.

NOTE: Gauge adapters with 2" diameter, 20-210°F scale, code NA10328 (1/2" sweat), NA10056 (3/4" sweat) or NA10058 (1" sweat) can be separately purchased and field installed to the Caleffi MixCal series 521 models sold without the integral gauge adapters.

After installation, the valve must be tested and commissioned in accordance with instructions given below, taking into account current applicable standards.

- 1) Ensure that the system is clean and free from dirt or debris before commissioning the thermostatic mixer.
- 2) It is recommended that the temperature is set using a suitable calibrated digital thermometer. The valve must be commissioned by measuring the temperature of the mixed water emerging at the point of use.
- 3) The maximum outlet temperature from the valve must be set taking account of the fluctuations due to simultaneous use. It is essential for these conditions to be stabilised before commissioning.
- 4) Adjust the temperature using the adjusting knob on the valve. For safety reasons, it is advisable to limit the maximum mixed water temperature to 120°F in domestic hot water systems.

Temperature adjustment

The temperature is set to the required value by means of the knob with a graduated scale, on the top of the valve.

Pos.	Min.	1	2	3	4	5	6	7	Max
T (°F)	81	90	100	111	120	127	138	145	152

with: $T_{Hot} = 155^{\circ}F (68^{\circ}C)$. $T_{Cold} = 55^{\circ}F (13^{\circ}C)$. $P = 43 \text{ psi (3 bar)}$

Application Diagrams

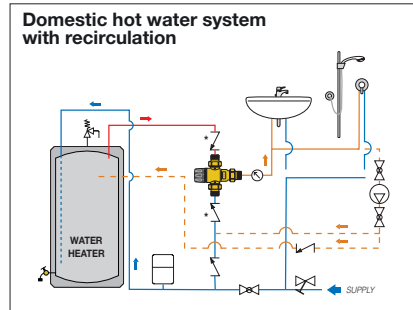
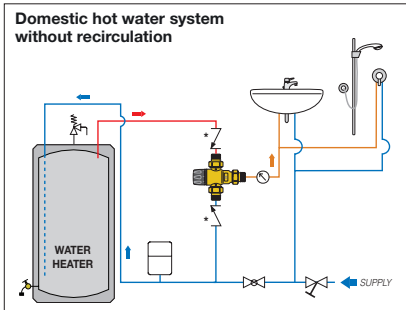
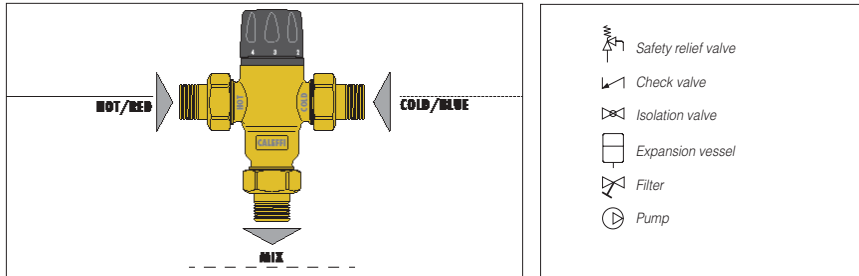

*MixCal series 521 thermostatic mixing valves with inlet check valves, "AC" models, can be used instead of separately installed check valves.

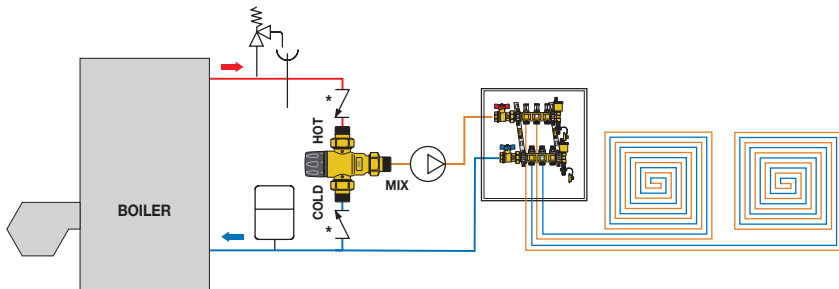

Radiant panels heating system

Replacement fittings

Item Description	Item quantity per valve	1/2 inch		3/4 inch			1 inch	
		NPT 521400A, AC 521410A, AC	Sweat 521409A, AC 521419A, AC	NPT 521500A, AC 521510A, AC	Sweat 521509A, AC 521519A, AC	Press 521506A 521516A	NPT 521600A, AC 521610A, AC	Sweat 521609A, AC 521619A, AC
Union washer	3	F50055						
Union nut 1"	3	F61008					F61008	
Male tailpieces	3	R31981 (2 only – "410")	NA10002 (2 only – "419")	31901A (2 only – "510")	NA10003 (2 only – "519")	NA16265* (2 only – "516")	59817A* (2 only – "610")	59834A* (2 only – "619")
Inlet male tailpiece with check valve – "AC" models only	2	59893A	59904A	59840A	59905A	—	59894A	59906A
Outlet tailpiece – "AC" models only	1	R31981	NA10002	31901A	NA10003	—	59817A*	59834A*
Outlet adapter with temperature gauge	1	NA10358**	NA10328	NA10358**	NA10056	NA10358**	NA10358**	NA10058
	1	688003A						

*Tailpiece fitting with integral union nut. 1" NPT and Sweat models require only two separate 1" union nuts (F61008).

**NA10358 requires additional parts. Choose appropriate tailpiece, washers, and union nut to complete the adapter.

Troubleshooting

Under normal operating conditions the Caleffi 521 thermostatic mixing valve will provide a very high level of performance. However, in some circumstances, where the following maintenance schedule is not followed problems may arise.

Recommended maintenance schedule:

Tests should be conducted regularly to monitor the thermostatic mixing valve performance, as deterioration of performance could indicate that the valve and/or the system require maintenance. If, during these tests, the temperature of the mixed water has changed significantly in comparison with the previous test, the details given in the installation and commissioning sections should be checked and maintenance conducted.

The following should be checked regularly to ensure that the optimum performance levels of the valve are maintained. Check every 12 months at least, or more often if necessary.

- 1) Check and clean the system filters.
- 2) Check that any check valves positioned upstream of the Caleffi thermostatic mixing valve are operating correctly, without problems caused by impurities.
- 3) Limescale can be removed from internal components of the thermostatic mixing valve by immersion in a suitable de-scaling fluid.
- 4) When the components which can be maintained have been checked, commission the valve.

Symptoms	Cause	Corrective action
Hot water at the cold taps	a) Operation of check valve is hindered; Check valve is not sealing correctly. b) Check valves not fitted.	- Replace faulty check valve
Fluctuating mixed water temperature	a) Erratic supply temperatures at the inlet of the valve. b) Starvation of the water supplies at the inlets of the valve. c) Incorrect commissioning of the valve.	- Restore inlet conditions within the limits of the valve.
Erratic flow of water from the valve	a) Insufficient water supplies b) Fluctuations in the supply pressures/temperatures. c) Adverse effect created by other draw off points on the system	- Stabilize inlet supply conditions.
No flow of water from the valve	a) In-line filters blocked. b) Insufficient supply pressures. c) Debris obstructing valve operation.	- Clean filters - Restore inlet supplies - Clean debris or scale from the valve.



Hydronic Solutions

Caleffi North America, Inc.
 3883 West Milwaukee Road
 Milwaukee, WI 53208

T: 414.238.2360 F: 414.238.2366